

O PRODUKTACH



2

**DRZWI RAMOWE**

SERIA X "KLASYKA"



4

SERIA X "MODERN"



6

SERIA XN



10

SERIA U



14

SERIA N

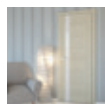

20

SERIA L

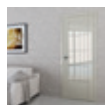

28

SERIA STP



32

**DRZWI PŁYTOWE**

SERIA Z



38

SERIA E

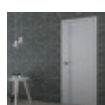

42

SERIA ZN



46

SERIA NK

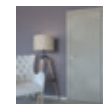

50

SERIA STK



54

SERIA LK



58

SERIA VG



62

SERIA SMK



66

AKCESORIA



74

SYSTEM OTWIERANIA  
INVISIBLE

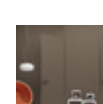

76

ŚCIANKI DZIAŁOWE  
Z ALUMINIOWYCH PROFILI



78

INFORMACJE  
TECHNICZNE

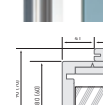

70

SIEĆ DYSTRYBUCJI



80

## O PRODUKTACH

*Produkty firmy ProfilDoors — to efekt wieloletniego doświadczenia, ciągłego monitorowania światowych trendów, stylów, innowacji oraz użycia wyłącznie zaawansowanych technologicznie materiałów najlepszych światowych producentów.*

### ASORTYMENT PRODUKTÓW OBEJMUJE:

- szeroki wybór drzwi wewnętrznych w różnych stylach o wyjątkowym wykończeniu oraz w różnych kategoriach cenowych
- rozmaite systemy otwierania drzwi wewnętrznych
- innowacyjne rozwiązania wykorzystane do produkcji ościeżnic bezprzylgowych regulowanych, aluminiowych
- konstrukcje inżynieryjne i przesuwne ścianki działowe
- listwy przypodłogowe i panele ściennie o wykończeniu identycznym, jak drzwi wewnętrzne



### ABOUT THE PRODUCT

LONG TERM EXPERIENCE, CONSTANT TRACING OF GENERAL DOOR MANUFACTURING TRENDS AND FASHION, CONSTANT INNOVATIONS IMPLEMENTATION, AND THE USE OF HIGH-TECH MATERIALS FROM LEADING MANUFACTURERS HAVE RESULTED IN TOP-QUALITY OUTPUT.

Our offer includes:

- a wide choice of interior doors in different styles with unique coatings and of various price categories
- various opening systems of interior doors
- innovative wooden, aluminium and steel door frames for rabbet-free doors
- special-purpose doors
- various engineering structures and sliding dividers
- floor moldings and wall panels, decorated the same way as the interior doors





# X SERIA X „KLASYKA”

Kolekcja drzwi ramowych Serii X „Klasyk” – to szeroki wybór drzwi zarówno we współczesnym, jak i w tradycyjnym, klasycznym stylu. Cechy charakterystyczne tej kolekcji to rozbieralna konstrukcja oraz ekologiczna powierzchnia „Polipropylen”. Obecnie kolekcja obejmuje 36 modeli w 6 kolorach.

**6**  
kolorów

**36**  
modeli

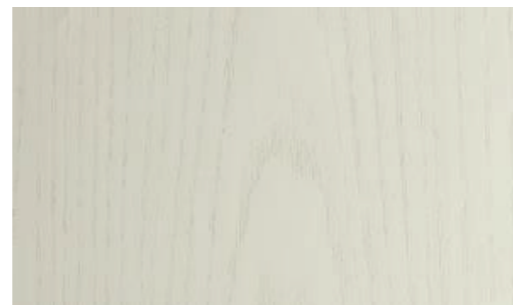

**BIAŁY POPIÓŁ**  
ASH WHITE

## SERIES X CLASSIC

This collection of panel doors is represented by a wide choice of doors both in modern and in traditional classical styles. The collapsible structure and the environmentally friendly “Polypropylene” coating are the most distinctive features of this collection.

The collection includes 36 models in 6 colors.

## CECHY KONSTRUKCYJNE

DESIGN FEATURES:



**DRZWI PRZESUWNE**  
Sliding door



**SYSTEM OBROTOWY**  
Pivot system



**SYSTEM BEZPRZYLGOWY**  
Frame for rabbet-free doors



**NAŚWIETLA / DOŚWIETLA**  
Transom / sidelight



**DRZWI DWUSKRZYDŁOWE**  
Double wing door



**DRZWI PRZESUWNE IZYDA**  
Sliding door IZYDA



**OSZKLENIE TRANSPARENTNE**  
Translucent glass glazing



**ROZBIERALNA KONSTRUKCJA**  
Collapsible structure



**AUTOMATYCZNY PRÓG**  
Automatic threshold



**DRZWI SKŁADANE**  
Folding door



27X BIAŁY POPIÓŁ

27X ASH WHITE

## KOLORY TEKSTUR

TEXTURE  
COLORS



## OŚCIEŻNICA BEZPRZYLGOWA REGULOWANA

ADJUSTABLE FRAME  
FOR RABBET-FREE  
DOORS



## LISTWA DEKORACYJNA DLA MODELI OD 23X DO 28X

DECORATIVE  
MOLDINGS  
IN MODELS FROM 23X TO 28X

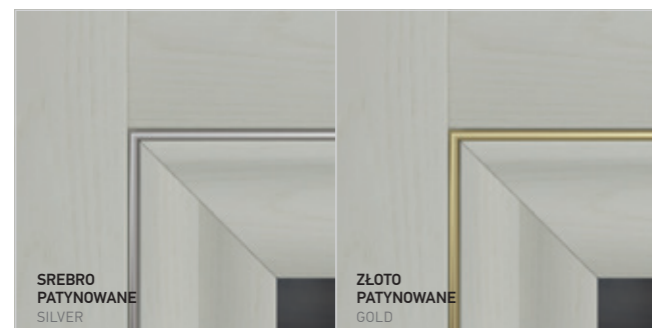

## OSZKLENIE GLASS

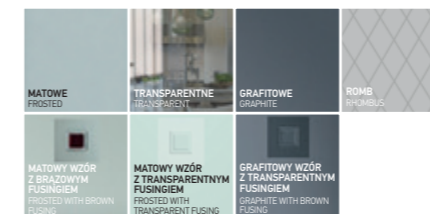

## MODELE MODELS

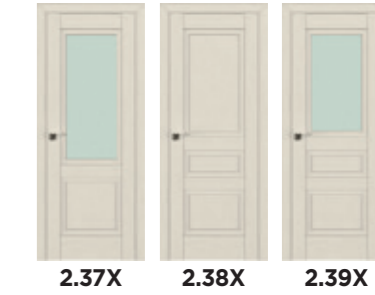
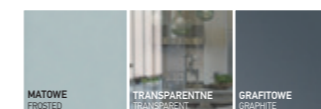
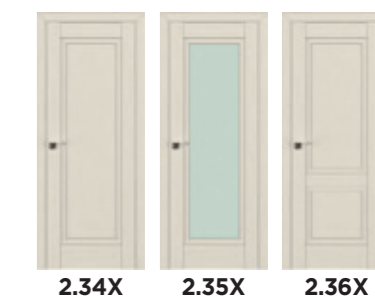
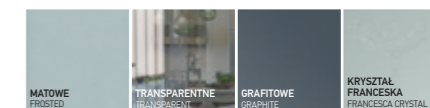
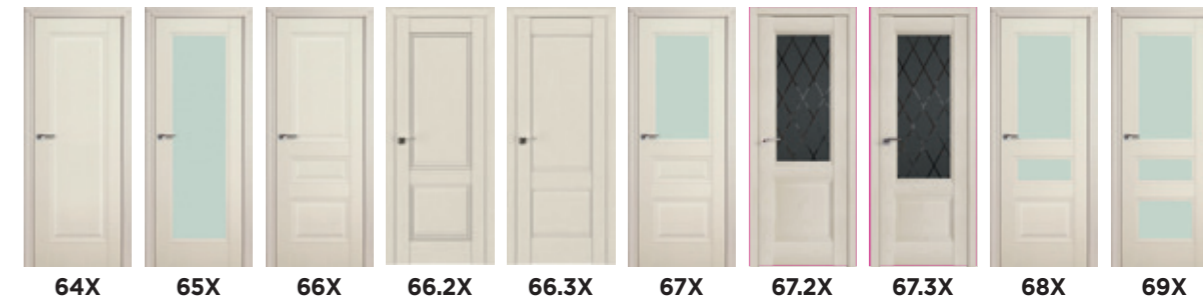
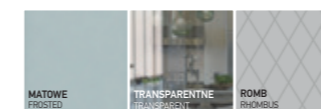



# X SERIA X „MODERN”

Kolekcja drzwi ramowych Serii X „MODERN” to szeroki wybór drzwi w różnych współczesnych stylach.

Cechy charakterystyczne tej kolekcji to rozbieralna konstrukcja oraz ekologiczna powierzchnia „Polipropylen”. Obecnie kolekcja obejmuje 33 modele w 5 kolorach.

5 kolorów  
33 modele



CAPPUCCINO MELINGA  
CAPPUCCINO MELINGA

## SERIES X MODERN

This collection of panel doors is represented by a wide choice of doors in various modern styles. The collapsible structure and the environmentally friendly “Polypropylene” coating are the most distinctive features of this collection. The collection includes 33 models in 5 colors.

## CECHY KONSTRUKCYJNE

DESIGN FEATURES:



DRZWI PRZESUWNE  
Sliding door



SYSTEM OBROTOWY  
Pivot system



SYSTEM BEZPRZYLGOWY  
Frame for rabbit-free doors



NAŚWIETLA / DOŚWIETLA  
Transom / sidelight



DRZWI DWUSKRZYDŁOWE  
Double wing door



DRZWI PRZESUWNE IZYDA  
Sliding door IZYDA



OSZKLENIE TRANSPARENTNE  
Translucent glass glazing



ROZBIERALNA KONSTRUKCJA  
Collapsible structure



AUTOMATYCZNY PRÓG  
Automatic threshold



DRZWI SKŁADANE  
Folding door



57X CAPPUCCINO MELINGA

**KOLORY  
TEKSTUR**

TEXTURE  
COLORS

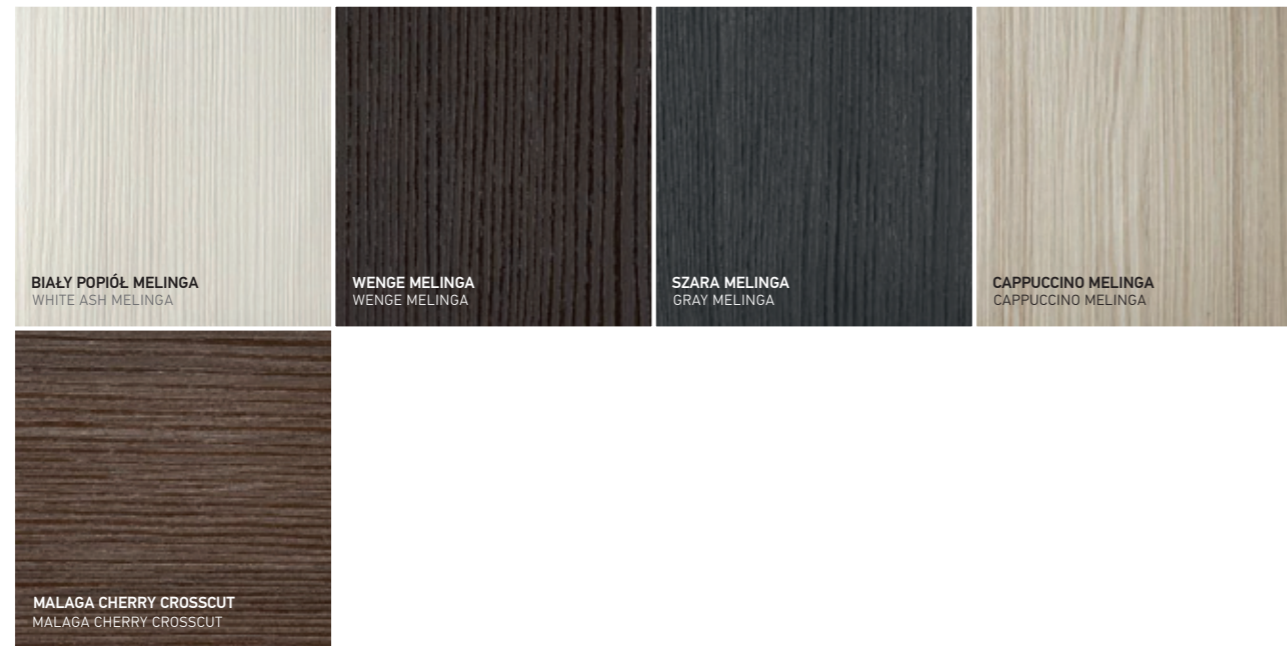

**OŚCIEŻNICA  
BEZPRZYLGOWA  
REGULOWANA**

ADJUSTABLE FRAME  
FOR RABBET-FREE  
DOORS

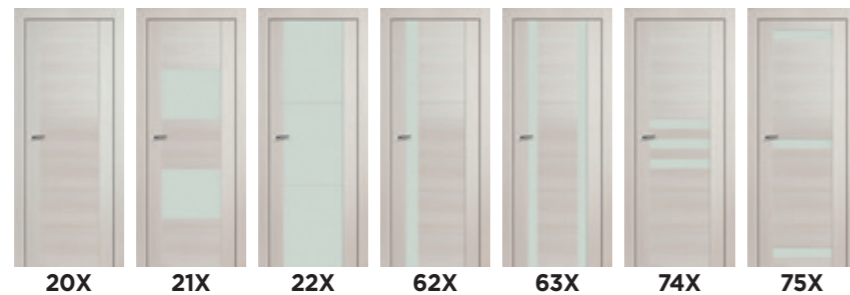
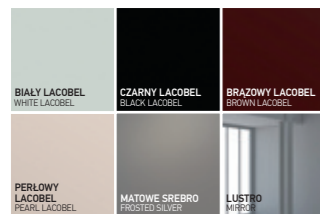

**OSZKLENIE** GLASS PATTERNS

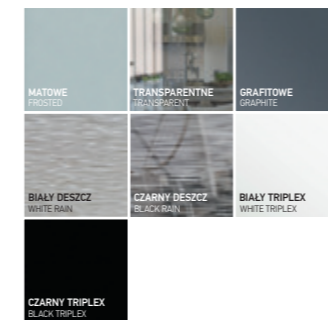

**MODELE** MODELS

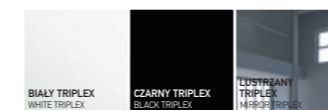



**XN**

SERIA XN

Kolekcja drzwi ramowych z wykończeniem polipropylenowym z ekskluzywną teksturą, która idealnie imituje naturalny dąb. Seria oferuje duży wybór drzwi zarówno w klasycznej, jak i współczesnej stylistyce. Kolekcja obejmuje 69 modeli w 9 kolorach.

**9**  
kolorów

**74**  
modeli



**MONT BLANC**  
MONT BLANC

**XN SERIES**

This is a collection of panel doors which are coated with polypropylene film having unique texture that imitates oak timber cut. A wide choice of doors both in classical and in modern styles is offered.

The collection includes 74 models in 9 colors.

**CECHY KONSTRUKCYJNE**

DESIGN FEATURES:



**DRZWI PRZESUWNE**  
Sliding door



**SYSTEM OBROTOWY**  
Pivot system



**SYSTEM BEZPRZYLGOWY**  
Frame for rabbet-free doors



**NAŚWIETLA / DOŚWIETLA**  
Transom / sidelight



**DRZWI DWUSKRZYDŁOWE**  
Double wing door



**DRZWI PRZESUWNE IZYDA**  
Sliding door IZYDA



**OSZKLENIE TRANSPARENTNE**  
Translucent glass glazing



**ROZBIERALNA KONSTRUKCJA**  
Collapsible structure



**AUTOMATYCZNY PRÓG**  
Automatic threshold



**DRZWI SKŁADANE**  
Folding door





**KOLORY  
TEKSTUR**

TEXTURE  
COLORS



**OŚCIEŻNICA  
BEZPRZYLGOWA  
REGULOWANA**

ADJUSTABLE FRAME  
FOR RABBET-FREE  
DOORS

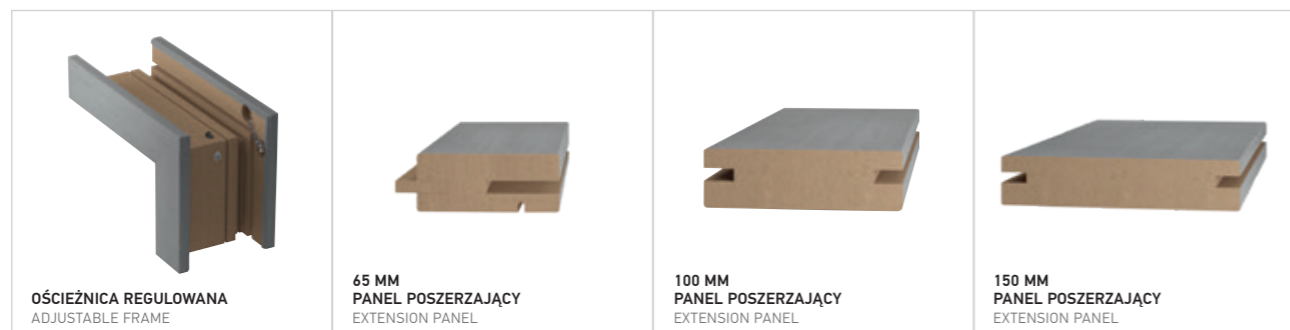

**OSZKLENIE** GLASS PATTERNS

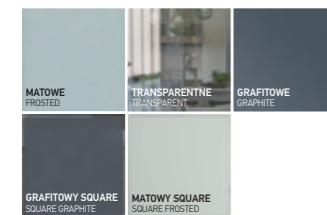

**MODELE** MODELS



**OSZKLENIE** GLASS PATTERNS

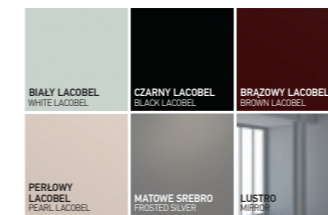

**MODELE** MODELS

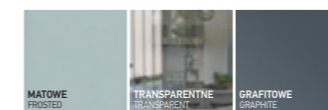
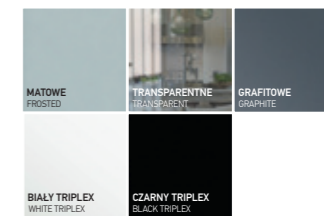
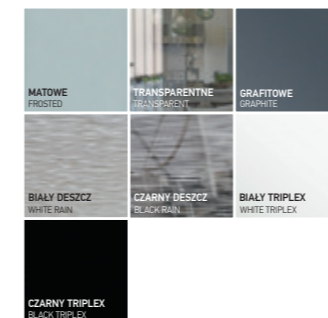



**OSZKLENIE** GLASS PATTERNS



**MODELE** MODELS

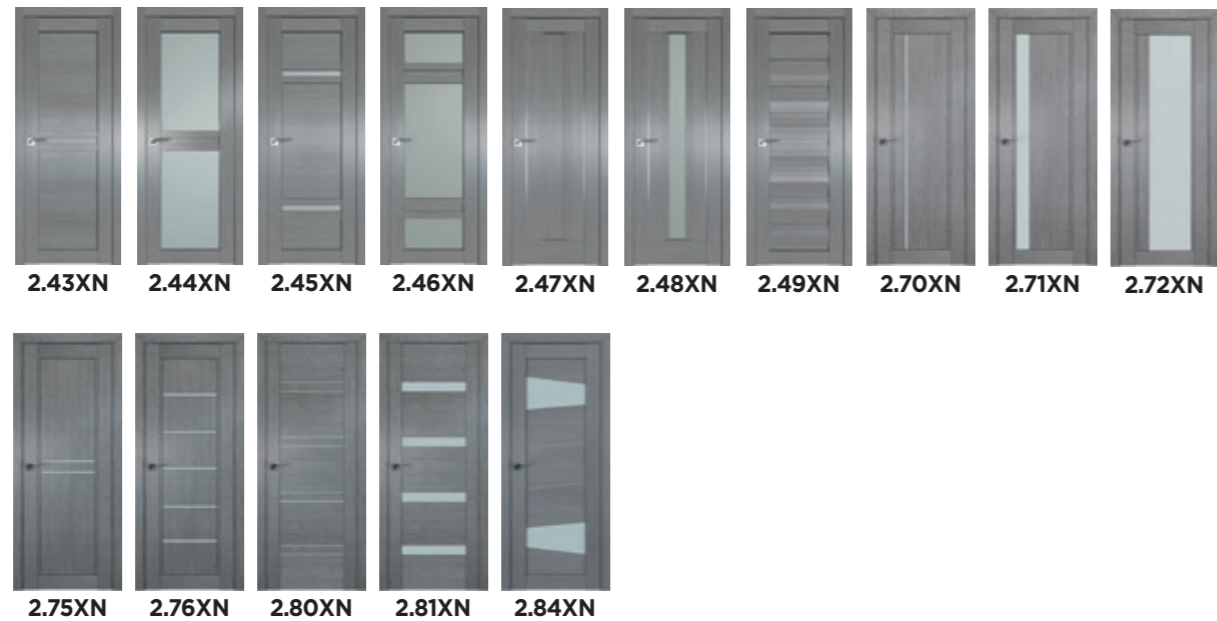
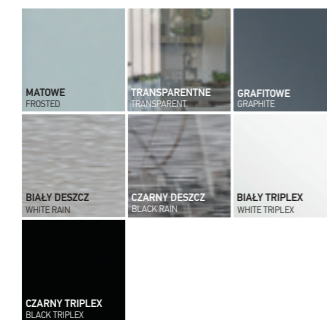
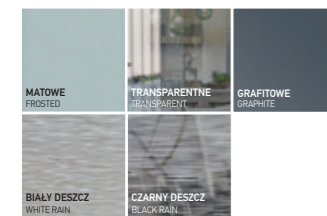

# U SERIA U

Kolekcja drzwi ramowych z jednobarwnym wykończeniem w postaci polipropylenu z ochronnym lakierem «Unilack», który chroni przed blaknięciem. Seria oferuje duży wybór drzwi zarówno w klasycznej, jak i współczesnej stylistyce. Obecnie kolekcja obejmuje 131 modelei w 7 kolorach.

**7**  
kolorów

**131**  
modele



**MANHATTAN**  
MANHATTAN

## U SERIES

This is a collection of panel doors which are coated with single-color polypropylene film having protective lacquer finish that prevents fading of the colors. This collection is represented by a wide choice of doors both in classical and in modern styles.

The collection includes 131 models in 7 colors.

## CECHY KONSTRUKCYJNE

DESIGN FEATURES:



**DRZWI PRZESUWNE**  
Sliding door



**SYSTEM OBROTOWY**  
Pivot system



**SYSTEM BEZPRZYLGOWY**  
Frame for rabbit-free doors



**NAŚWIETLA / DOŚWIETLA**  
Transom / sidelight



**DRZWI DWUSKRZYDŁOWE**  
Double wing door



**DRZWI PRZESUWNE IZYDA**  
Sliding door IZYDA



**ROZBIERALNA KONSTRUKCJA**  
Collapsible structure



**AUTOMATYCZNY PRÓG**  
Automatic threshold



**DRZWI SKŁADANE**  
Folding door



**NADRUKI NA DRZWIACH**  
Art print on the door



1U MANHATTAN



**KOLORY  
TEKSTUR**

TEXTURE  
COLORS



**OŚCIEŻNICA  
BEZPRZYLGOWA  
REGULOWANA**

ADJUSTABLE FRAME  
FOR RABBET-FREE  
DOORS

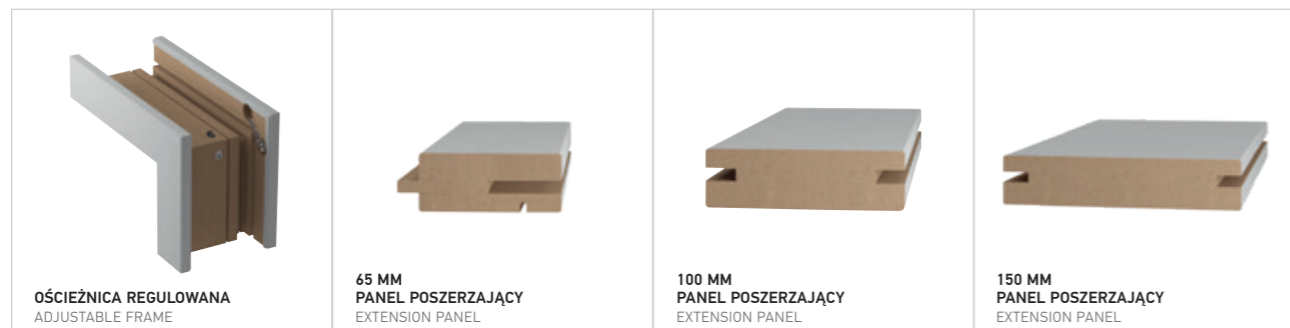

**LISTWA  
DEKORACYJNA  
DLA MODELI OD 23U DO 28U**

DECORATIVE  
MOLDINGS  
IN MODELS FROM 23U TO 28U

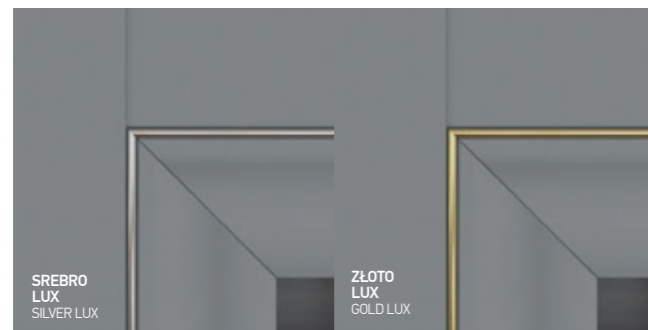

**OSZKLENIE** GLASS PATTERNS



**MODELE** MODELS

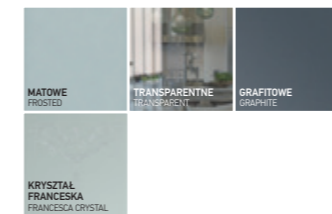
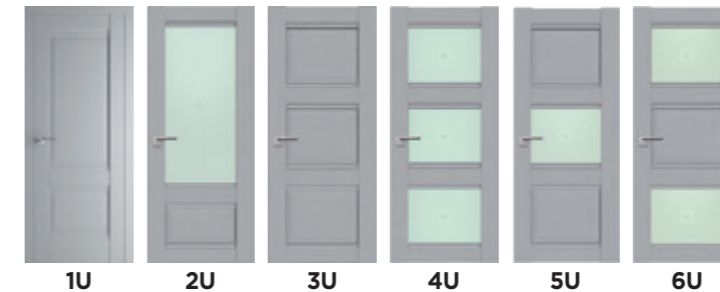

OSZKLENIE GLASS PATTERNS

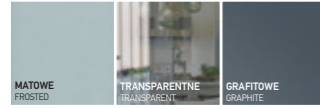

MODELE MODELS



100U 101U 102U 103U 104U 105U 106U 107U 108U 109U



2.26U 2.27U 2.28U 2.29U 2.30U 2.31U 2.32U 2.33U 2.41U 2.42U

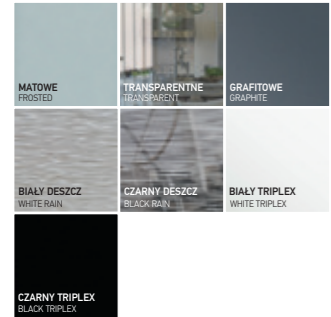

2.43U 2.44U 2.45U 2.46U 2.47U 2.48U 2.70U 2.71U 2.72U 2.75U



2.76U 2.80U 2.84U

OSZKLENIE GLASS PATTERNS

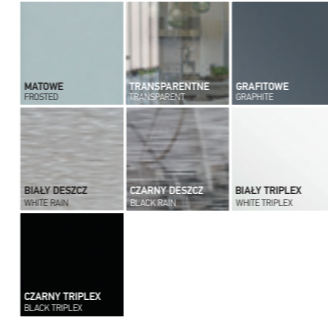

MODELE MODELS



7U 17U 29U 30U 34U 35U 37U 38U 39U 45U



46U 47U 48U 49U 52U 53U 70U 71U 72U 98U



99U 2.08U 2.09U 2.10U 2.11U

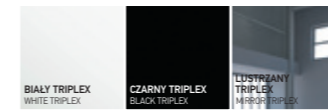

8U



OSZKLENIE GLASS PATTERNS

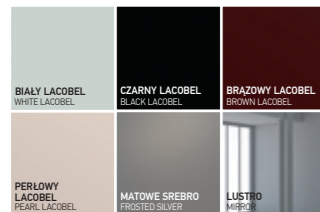

MODELE MODELS



20U 21U 22U 62U 63U 74U 75U 150U 2.01U 2.03U



2.04U 2.05U 2.07U

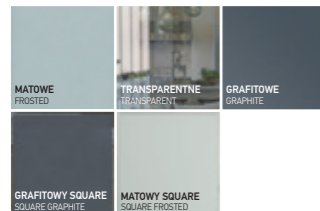

2.12U 2.13U 2.14U 2.15U 2.16U 2.17U 2.19U 2.85U 2.86U 2.87U



2.88U 2.89U 2.90U 2.91U 2.92U 2.93U 2.94U

OSZKLENIE GLASS PATTERNS

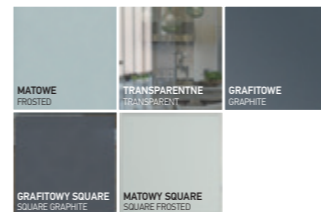

MODELE MODELS



2.100U 2.101U 2.102U 2.103U



2.104U 2.105U 2.106U 2.107U



2.108U 2.109U

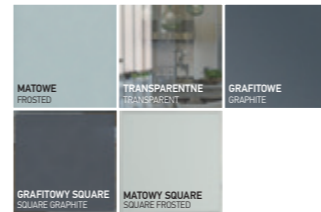

2.116U 2.117U



# N SERIA N

Kolekcja drzwi ramowych z wykończeniem polipropylenowym z ekskluzywną teksturą, która idealnie imituje naturalny dąb. Obecnie kolekcja obejmuje 13 modeli w 3 kolorach.

**3**  
kolory

**13**  
modeli



**DĄB SKY CREAM**  
OAK SKY CREAM

## N SERIES

This is a collection of panel doors which are coated with polypropylene film having unique texture that imitates oak timber cut.

The collection includes 13 models in 3 colors.

## CECHY KONSTRUKCYJNE

DESIGN FEATURES:



**DRZWI PRZESUWNE**  
Sliding door



**SYSTEM OBROTOWY**  
Pivot system



**SYSTEM BEZPRZYLGOWY**  
Frame for rabbet-free doors



**NAŚWIETLA / DOŚWIETLA**  
Transom / sidelight



**DRZWI DWUSKRZYDŁOWE**  
Double wing door



**DRZWI PRZESUWNE IZYDA**  
Sliding door IZYDA



**OSZKLENIE TRANSPARENTNE**  
Translucent glass glazing



**ROZBIERALNA KONSTRUKCJA**  
Collapsible structure



**AUTOMATYCZNY PRÓG**  
Automatic threshold



**DRZWI SKŁADANE**  
Folding door





**KOLORY  
TEKSTUR**

TEXTURE  
COLORS

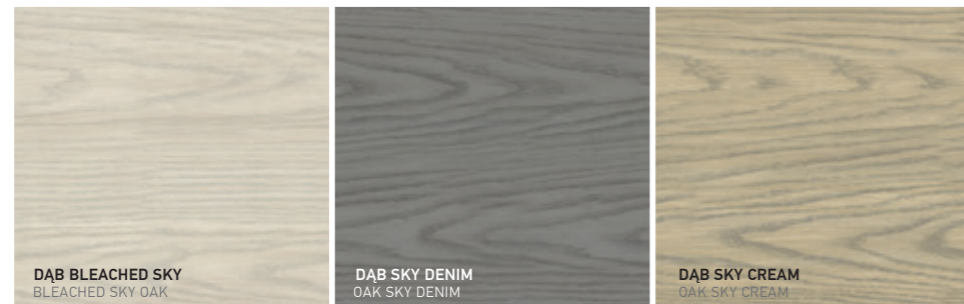

**OŚCIEŻNICA  
BEZPRZYLGOWA  
REGULOWANA**

ADJUSTABLE FRAME  
FOR RABBET-FREE  
DOORS



**OSZKLENIE** GLASS PATTERNS

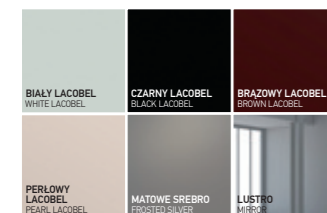

**MODELE** MODELS

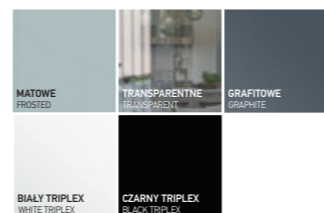
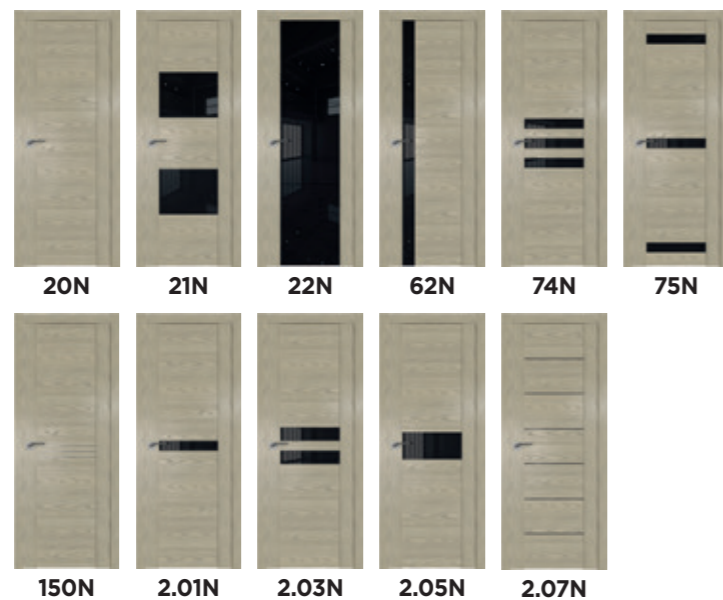

# L SERIA L

Kolekcja drzwi ramowych z polerowaną powłoką, opracowaną w Niemczech. Powłoka ta wyróżnia się wysoką jakością powierzchni oraz połysku. Seria zawiera szeroki asortyment drzwi zarówno w klasycznej, jak i w nowoczesnej stylistyce. Obecnie kolekcja obejmuje 55 modelei w 4 kolorach.

**4**  
kolory

**55**  
modele



**OTOCZAK LUX**  
PEBBLE LUX

## L SERIES

This is a collection of panel doors with glossy coating which was developed in Germany. This coating is notable for the superior quality of its surface and outstanding glittering effect. This collection is represented by a wide choice of doors both in classical and in modern styles. The collection includes 55 models in 4 colors.

## CECHY KONSTRUKCYJNE

DESIGN FEATURES:



**DRZWI PRZESUWNE**  
Sliding door



**SYSTEM OBROTOWY**  
Pivot system



**SYSTEM BEZPRZYLGOWY**  
Frame for rabbit-free doors



**NAŚWIETLA / DOŚWIETLA**  
Transom / sidelight



**DRZWI DWUSKRZYDŁOWE**  
Double wing door



**DRZWI PRZESUWNE IZYDA**  
Sliding door IZYDA



**OSZKLENIE TRANSPARENTNE**  
Translucent glass glazing



**ROZBIERALNA KONSTRUKCJA**  
Collapsible structure



**AUTOMATYCZNY PRÓG**  
Automatic threshold





**KOLORY  
TEKSTUR**

COLOR  
TEXTURE



**OŚCIEŻNICA  
BEZPRZYLGOWA  
REGULOWANA**

ADJUSTABLE FRAME  
FOR RABBET-FREE  
DOORS

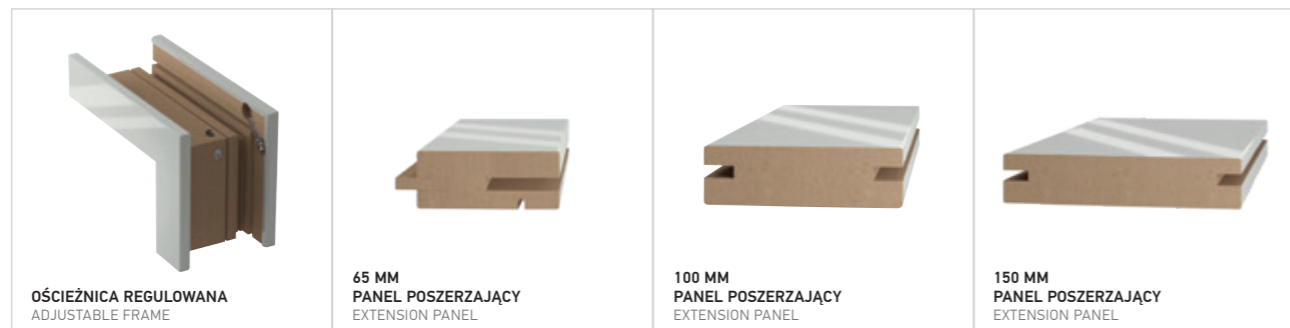

**LISTWA  
DEKORACYJNA  
DLA MODELI OD 23L DO 28L  
ORAZ 96L, 97L**

DECORATIVE  
MOLDINGS  
IN MODELS FROM 23L TO 28L  
AND 96L, 97L



**OSZKLENIE** GLASS PATTERNS

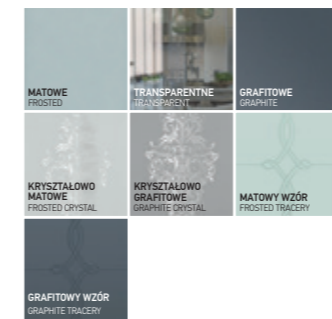

**MODELE** MODELS

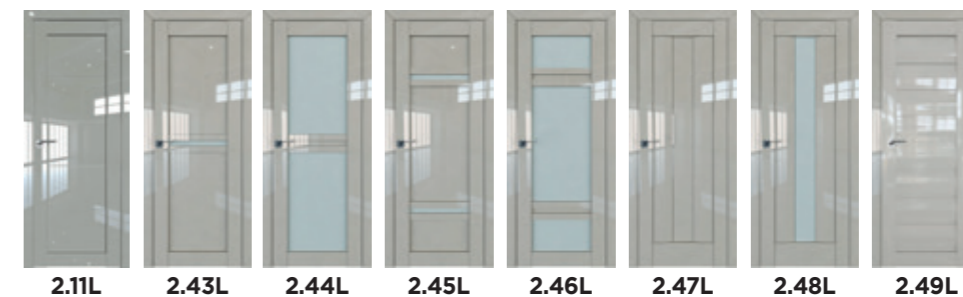
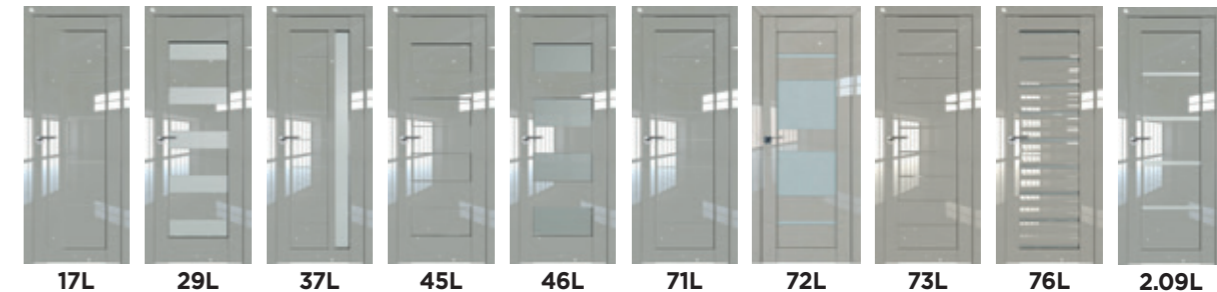
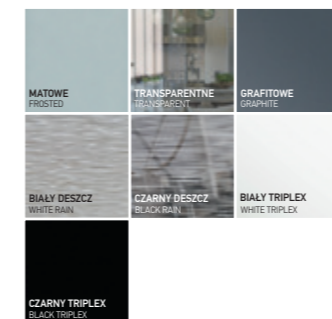
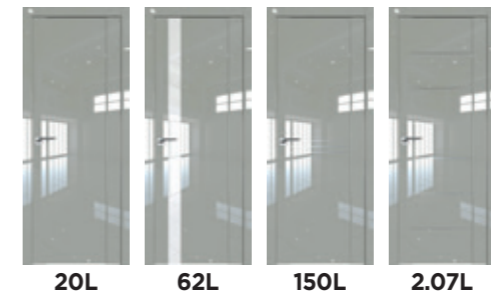
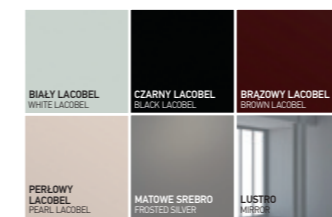
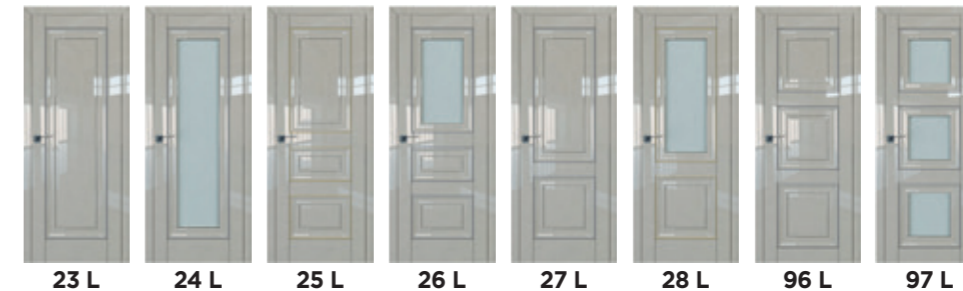

OSZKLENIE GLASS PATTERNS

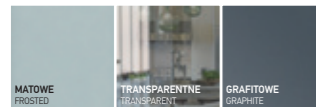

MODELE MODELS



100L 101L 102L 103L 104L 105L

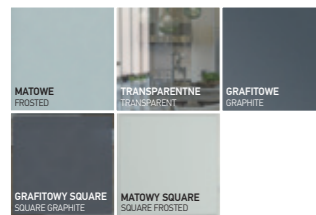

2.12L 2.13L 2.14L 2.15L 2.16L 2.17L 2.18L 2.19L

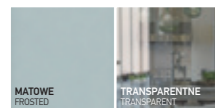

2.100L 2.101L 2.102L 2.103L 2.104L 2.105L 2.106L 2.107L 2.108L 2.109L

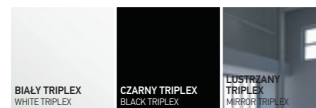

8L





# STP

## SERIA STP

Kolekcja drzwi ramowych z najnowszym ekskluzywnym wykończeniem w postaci powłoki, imitującej teksturę naturalnego drewna. Cechą szczególną tego wykończenia jest wyraźna i głęboka struktura „szczotkowana” pokryta jednobarwnym lakierem błyszczącym lub matowym. Seria zawiera szeroki asortyment drzwi we współczesnym minimalistycznym stylu. Obecnie kolekcja obejmuje 29 modeli w 3 kolorach.

### STP SERIES

This is a collection of panel doors which are finished with the newest unique film coating imitating natural veneer sheet texture. Clear and deep groovy surface covered with matt or glossy single-color lacquer is the most distinctive feature of this coating. This collection is represented by a wide choice of doors in modern minimalistic style. The collection includes 29 models in 3 colors.

### CECHY KONSTRUKCYJNE

DESIGN FEATURES:



**DRZWI PRZESUWNE**  
Sliding door



**SYSTEM OBROTOWY**  
Pivot system



**SYSTEM BEZPRZYLGOWY**  
Frame for rabbit-free doors



**NAŚWIETLA / DOŚWIETLA**  
Transom / sidelight



**DRZWI DWUSKRZYDŁOWE**  
Double wing door



**DRZWI PRZESUWNE IZYDA**  
Sliding door IZYDA



**OSZKLENIE TRANSPARENTNE**  
Translucent glass glazing



**ROZBIERALNA KONSTRUKCJA**  
Collapsible structure



**AUTOMATYCZNY PRÓG**  
Automatic threshold



**DRZWI SKŁADANE**  
Folding door

**3**  
kolory

**29**  
modeli



**CZERWONA SOSNA**  
PINE RED



2.05STP PINE RED



**KOLORY  
TEKSTUR**

TEXTURE  
COLORS



**OŚCIEŻNICA  
BEZPRZYLGOWA  
REGULOWANA**

ADJUSTABLE FRAME  
FOR RABBET-FREE  
DOORS



**OSZKLENIE** GLASS PATTERNS

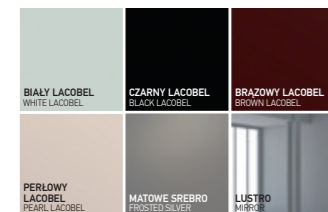

**MODELE** MODELS

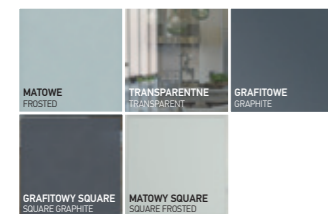

**OSZKLENIE** GLASS PATTERNS

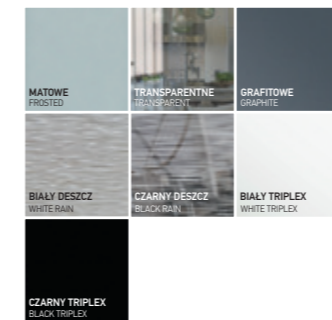

**MODELE** MODELS

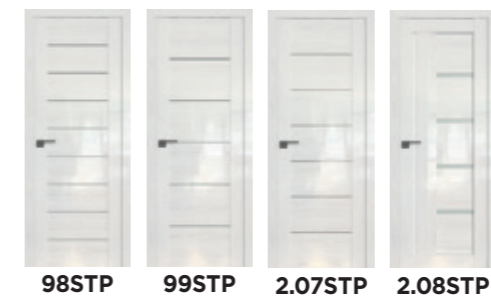
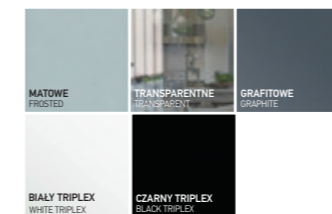



# Z SERIA Z

Kolekcja drzwi płytowych z powłoką polipropylenową oraz innowacyjnym designerskim rozwiązaniem – aluminiową nakładką na krawędziach skrzydła drzwi. Obecnie kolekcja obejmuje 18 modeli w 5 kolorach.

## Z SERIES

This is a collection of flush doors which are finished with the polypropylene coating. The innovative technological concept was introduced: decorative aluminium strap mounted on the edges of the door wing.

The collection includes 18 models in 5 colors.

5  
kolorów

18  
modeli



WENGE CROSSCUT  
WENGE CROSSCUT

## CECHY KONSTRUKCYJNE

DESIGN FEATURES:



DRZWI PRZESUWNE  
Sliding door



DRZWI PRZESUWNE IZYDA  
Sliding door IZYDA



DRZWI PRZESUWNE DIVA AIR  
Sliding door Diva Air



DRZWI PRZESUWNE MAGIC  
Sliding door Magic



SYSTEM OBROTOWY  
Pivot system



DRZWI SKŁADANE  
Folding door



DRZWI SKŁADANE COMPACK  
Folding door Compack



OŚCIEŻNICA UKRYTA  
Invisible door frame



SYSTEM BEZPRZYLGOWY  
Frame for rabbit-free doors



AUTOMATYCZNY PRÓG  
Automatic threshold



NAŚWIETLA / DOŚWIETLA  
Transom / sidelight



DRZWI DWUSKRZYDŁOWE  
Double wing door



OSZKLENIE TRANSPARENTNE  
Translucent glass glazing



OSZKLENIE NIEPRZE-  
PUSZCZAJĄCE ŚWIATŁA  
Opaque glass glazing

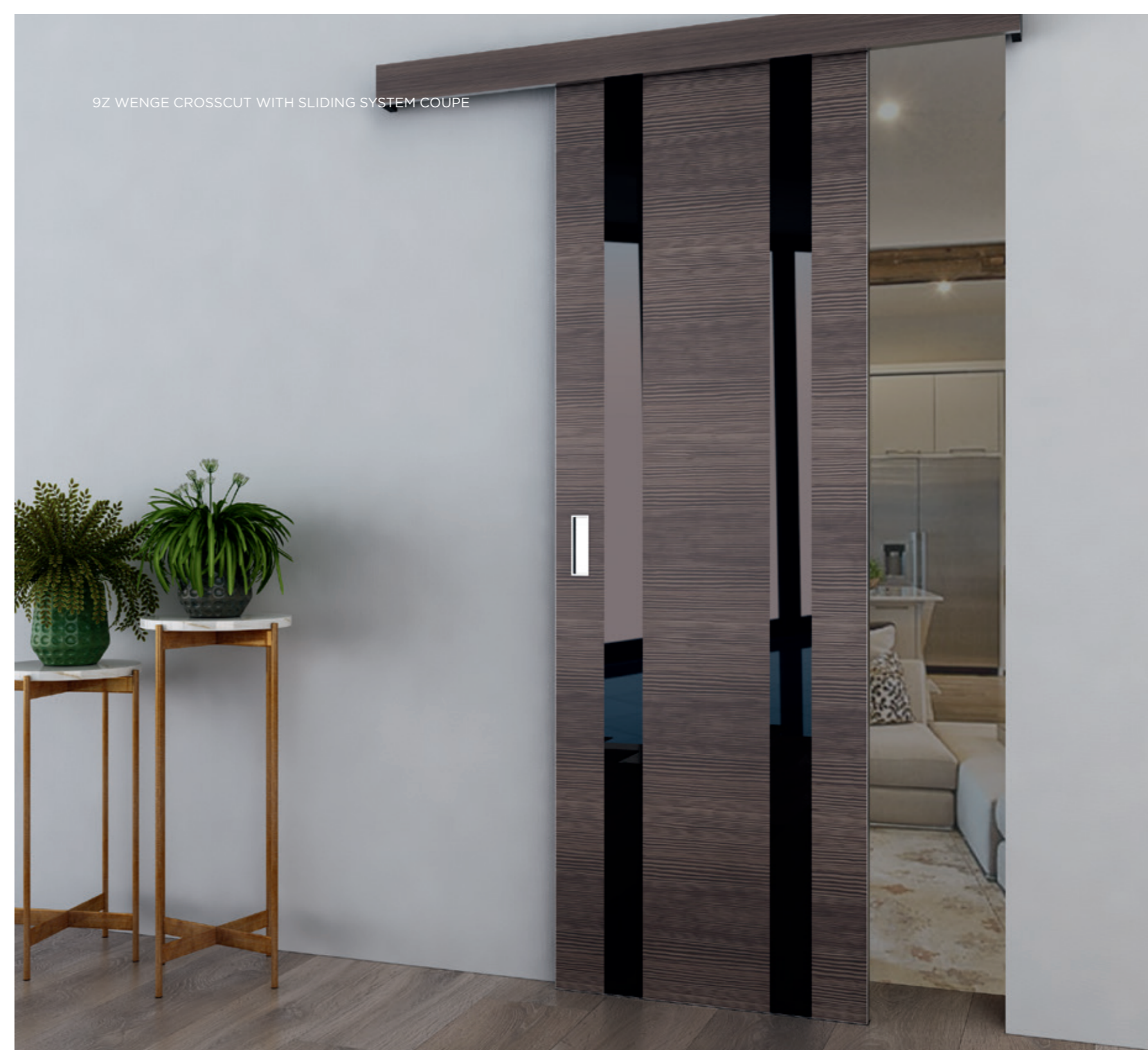

**KOLORY  
TEKSTUR**

TEXTURE  
COLORS

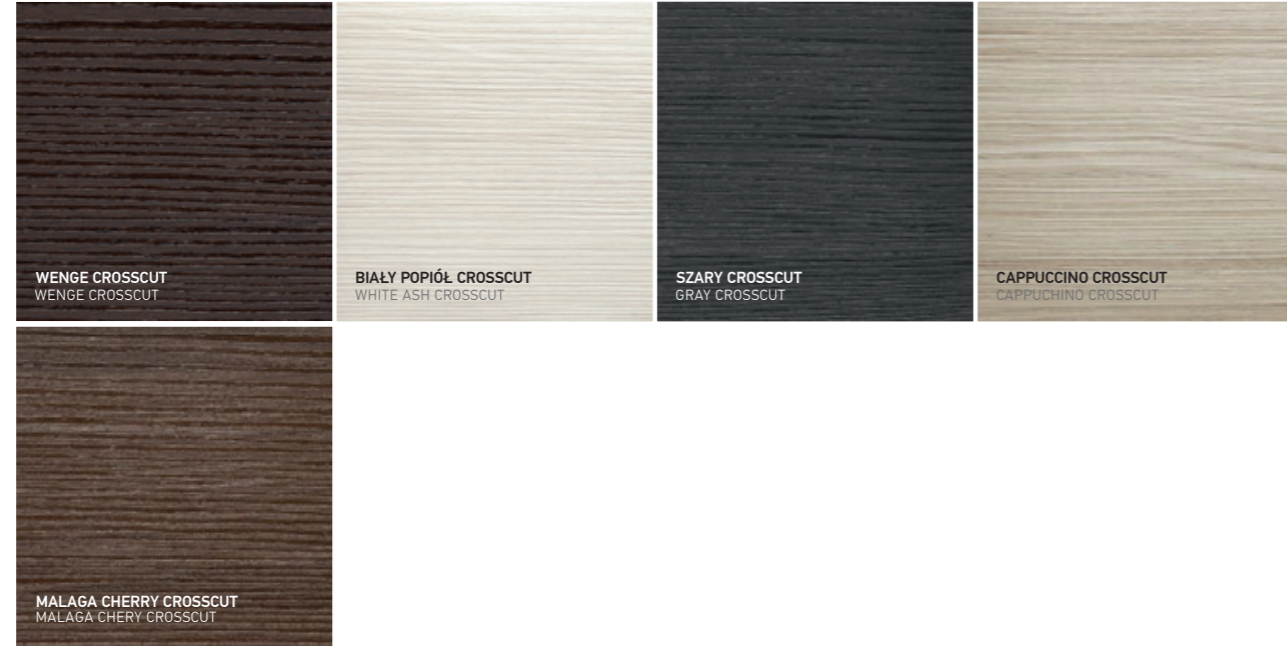

**OŚCIEŻNICA  
BEZPRZYLGOWA  
REGULOWANA**

ADJUSTABLE FRAME  
FOR RABBET-FREE  
DOORS



**NAKŁADKI  
DEKORACYJNE**

DECORATIVE EDGE

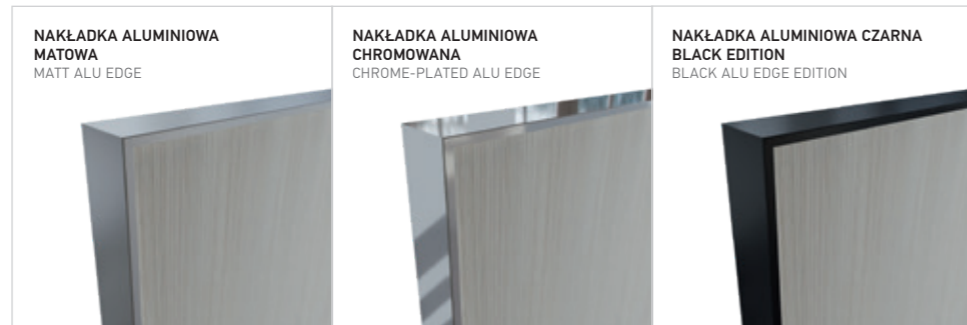

**OSZKLENIE** GLASS PATTERNS



**MODELE** MODELS



**WYKOŃCZENIE**  
DECORATION

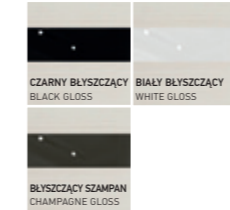

**MODELE**  
MODELS



**WYKOŃCZENIE**  
DECORATION

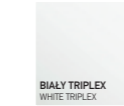

**MODELE**  
MODELS



**WYKOŃCZENIE** DECORATION

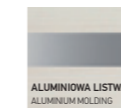

**MODELE** MODELS

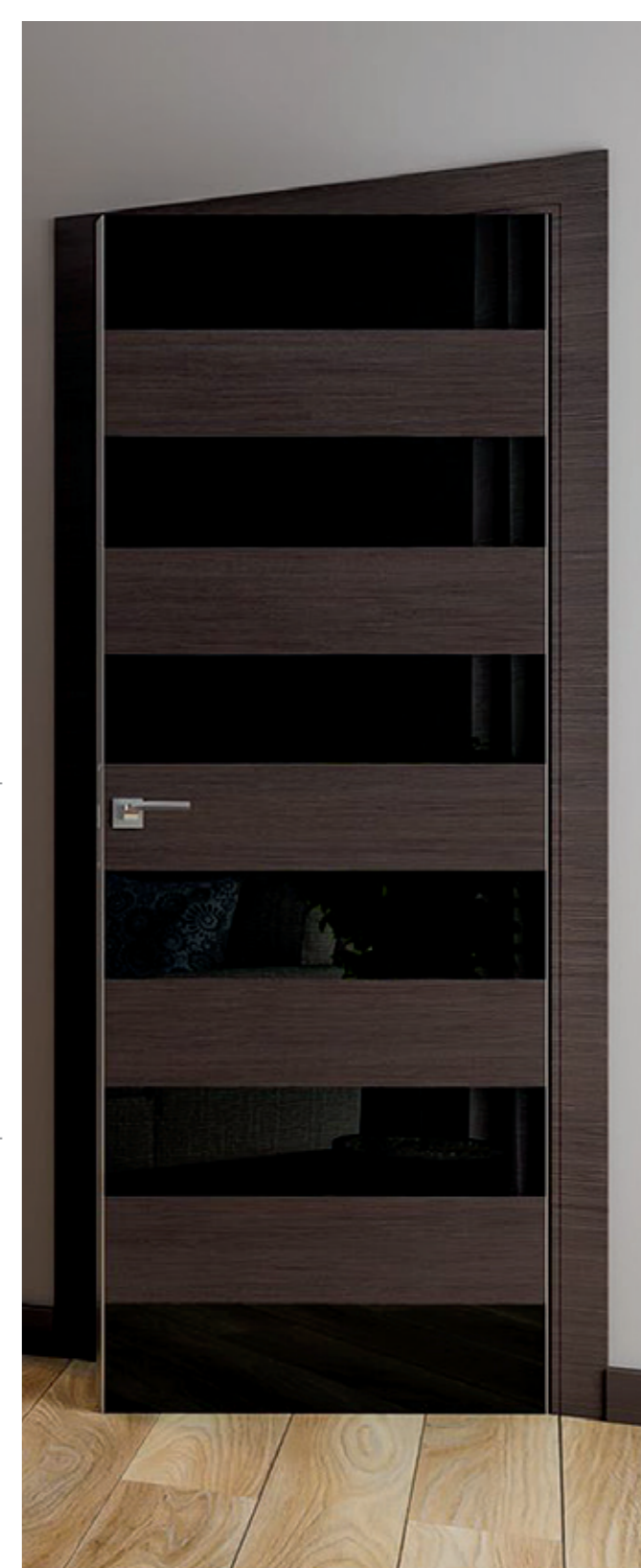



# E SERIA E

Kolekcja drzwi płytowych z jednobarwnym matowym polipropylenowym wykończeniem, pokrytym ochronnym lakierem „Unilack”, który chroni kolory przed blaknięciem. To wykończenie zostało opracowane specjalnie dla firmy ProfilDoors. Obecnie kolekcja obejmuje 25 modelei w 7 kolorach.

## SERIES E

This is a collection of flush doors which are coated with single-color polypropylene film having protective lacquer finish that prevents fading of the colors. This coating was developed on the request of ProfilDoors. The collection includes 25 models in 7 colors.

7  
kolorów

25  
modele



MANHATTAN  
MANHATTAN

## CECHY KONSTRUKCYJNE

### DESIGN FEATURES:

- |   |   |  |   |   |
|---|---|--|---|---|
|  <b>DRZWI PRZESUWNE</b><br>Sliding door              |  <b>DRZWI PRZESUWNE IZYDA</b><br>Sliding door IZYDA    |  <b>DRZWI PRZESUWNE DIVA AIR</b><br>Sliding door Diva Air |  <b>DRZWI PRZESUWNE MAGIC</b><br>Sliding door Magic                |  <b>SYSTEM OBROTOWY</b><br>Pivot system              |
|  <b>DRZWI SKŁADANE</b><br>Folding door               |  <b>DRZWI SKŁADANE COMPACK</b><br>Folding door Compack |  <b>OŚCIEŻNICA UKRYTA</b><br>Invisible door frame         |  <b>SYSTEM BEZPRZYLGOWY</b><br>Frame for rabbit-free doors         |  <b>NADRUKI NA DRZWIACH</b><br>Art print on the door |
|  <b>NAŚWIETLA / DOŚWIETLA</b><br>Transom / sidelight |  <b>DRZWI DWUSKRZYDŁOWE</b><br>Double wing door        |  <b>AUTOMATYCZNY PRÓG</b><br>Automatic threshold          |  <b>OSZKLENIE NIEPRZEPUSZAJĄCE ŚWIATŁA</b><br>Opaque glass glazing |   |



**KOLORY  
TEKSTUR**

TEXTURE  
COLORS



**OŚCIEŻNICA  
BEZPRZYLGOWA  
REGULOWANA**

ADJUSTABLE FRAME  
FOR RABBET-FREE  
DOORS

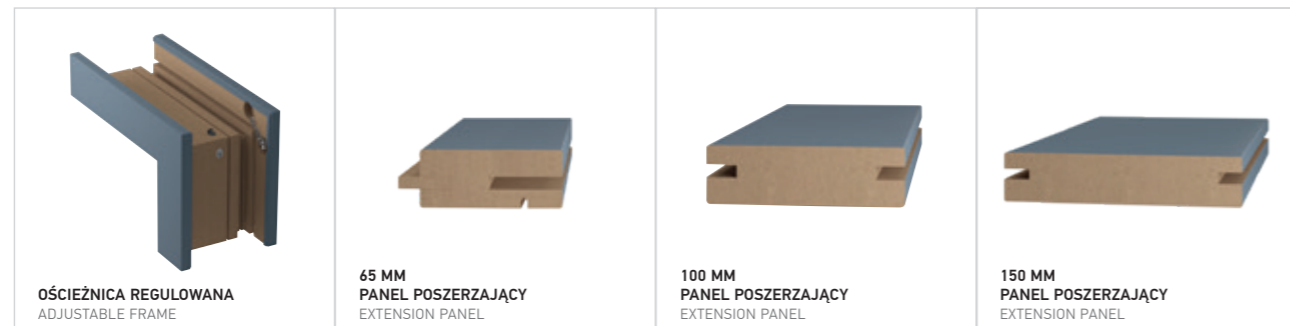

**LISTWA  
DEKORACYJNA  
DLA MODELI OD 50E DO 59E**

DECORATIVE  
MOLDINGS  
IN MODELS FROM 50E TO 59E

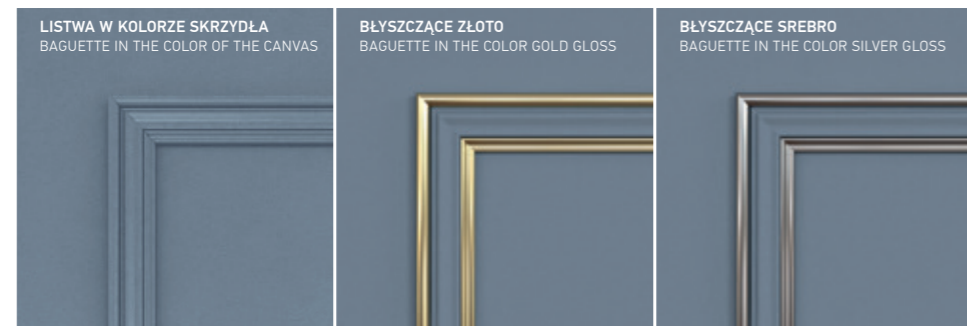

**NAKŁADKI DEKORACYJNE** DECORATIVE EDGE



**OSZKLENIE** GLASS PATTERNS

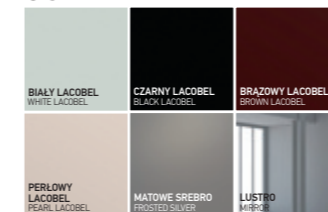

**MODELE** MODELS

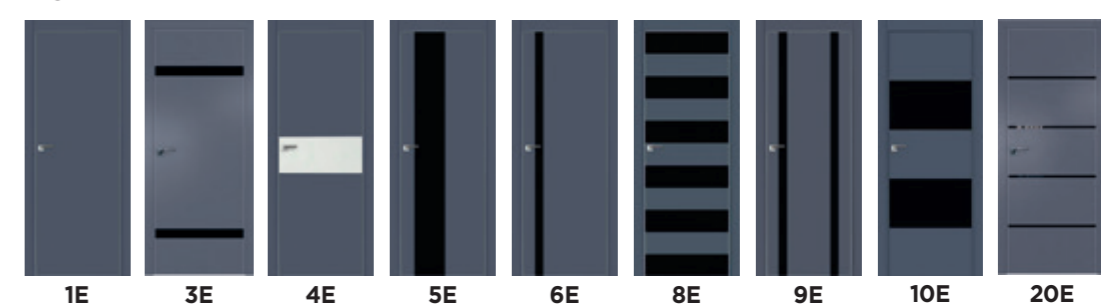

**WYKOŃCZENIE** DECORATION

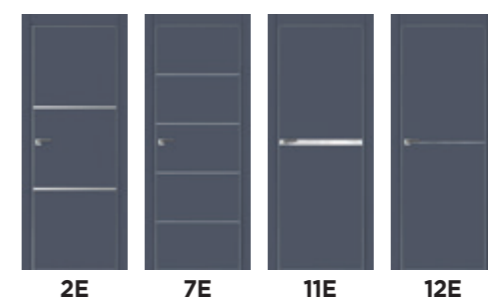

**OSZKLENIE  
SZKŁO HARTOWANE**  
TEMPERED GLASS PATTERNS



**OSZKLENIE** GLASS PATTERNS



**MODELE** MODELS





ZN

SERIA ZN

Kolekcja drzwi płytowych z wykończeniem polipropylenowym z ekskluzywną teksturą, która idealnie imituje naturalny dąb. Wykończenie to zostało opracowane specjalnie dla firmy ProfilDoors. Gama modeli oferuje duży wybór drzwi zarówno w klasycznej, jak i współczesnej stylistyce. Obecnie kolekcja obejmuje 26 modeli w 9 kolorach.

## ZN SERIES

This is a collection of panel doors which are coated with polypropylene film having unique texture that imitates oak timber cut. This coating was developed specially for ProfilDoors. This collection is represented by a wide choice of doors both in classical and in modern styles. The collection includes 26 models in 9 colors.

## CECHY KONSTRUKCYJNE

DESIGN FEATURES:



DRZWI PRZESUWNE  
Sliding door



DRZWI PRZESUWNE IZYDA  
Sliding door IZYDA



DRZWI PRZESUWNE DIVA AIR  
Sliding door Diva Air



DRZWI PRZESUWNE MAGIC  
Sliding door Magic



SYSTEM OBROTOWY  
Pivot system



DRZWI SKŁADANE  
Folding door



DRZWI SKŁADANE COMPACT  
Folding door Compact



OŚCIEŻNICA UKRYTA  
Invisible door frame



SYSTEM BEZPRZYLGOWY  
Frame for rabbit-free doors



NAŚWIETLA / DOŚWIETLA  
Transom / sidelight



DRZWI DWUSKRZYDŁOWE  
Double wing door



AUTOMATYCZNY PRÓG  
Automatic threshold



OSZKLENIE NIEPRZE-  
PUSZCZAJĄCE ŚWIATŁA  
Opaque glass glazing

9  
kolorów

26  
modeli



MONT BLANC  
MONT BLANC

14ZN MONT BLANC





**KOLORY  
TEKSTUR**

COLOR  
TEXTURE

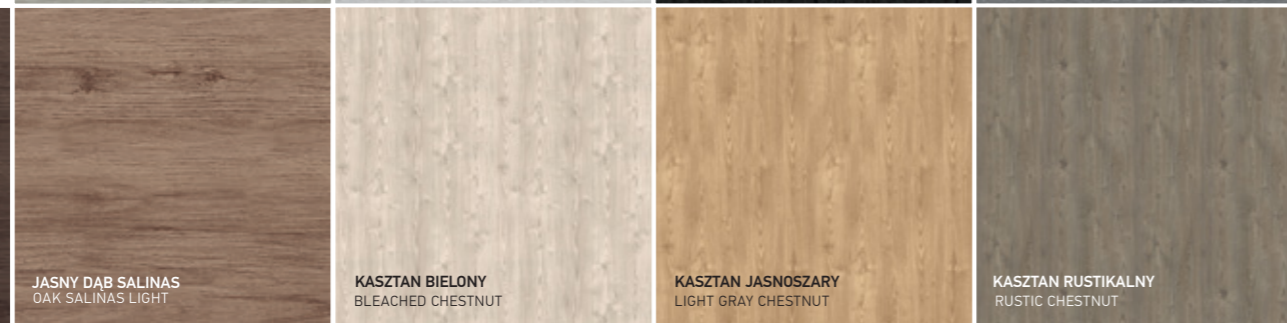

**OŚCIEŻNICA  
BEZPRZYLGOWA  
REGULOWANA**

ADJUSTABLE FRAME  
FOR RABBET-FREE  
DOORS

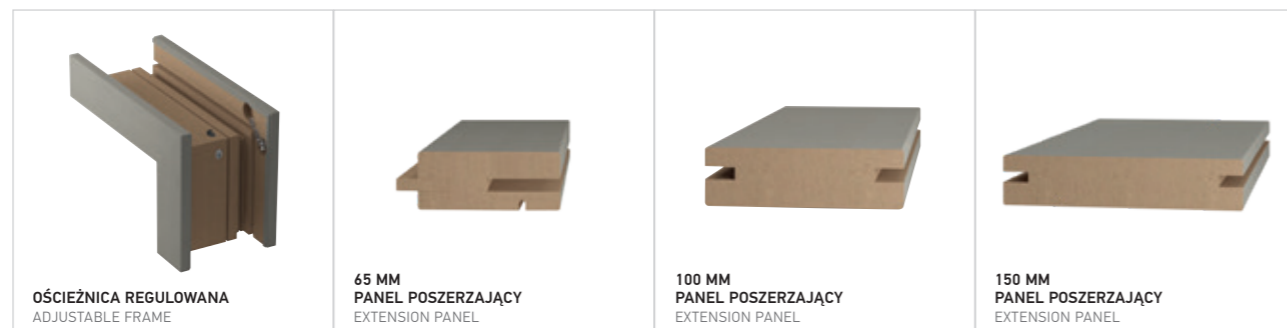

**LISTWA  
DEKORACYJNA  
DLA MODELI OD 50ZN DO  
59ZN**

DECORATIVE  
MOLDINGS  
IN MODELS FROM 50ZN TO 59ZN

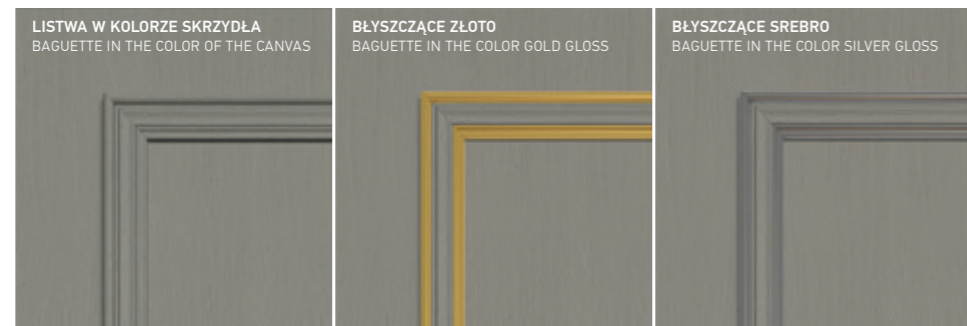

**NAKŁADKI DEKORACYJNE** DECORATIVE EDGE



**OSZKLENIE** GLASS PATTERNS

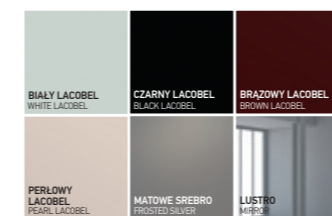

**MODELE** MODELS

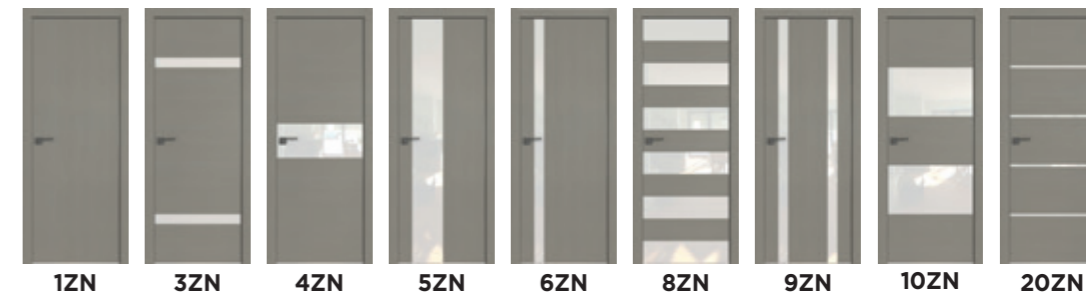

**WYKOŃCZENIE**  
DECORATION



**WYKOŃCZENIE**  
DECORATION

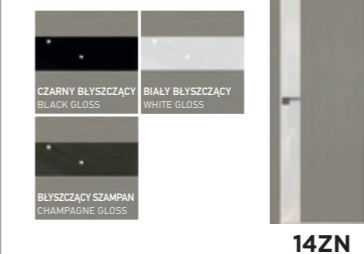

**OSZKLENIE  
SZKŁO HARTOWANE**  
TEMPERED  
GLASS PATTERNS



**OSZKLENIE** GLASS PATTERNS



**MODELE** MODELS





NK

SERIA NK

Kolekcja drzwi płytowych z wykończeniem polipropylenowym z ekskluzywną teksturą, która idealnie imituje naturalny dąb. Wykończenie to zostało opracowane przez firmę Renolit (Monachium) specjalnie dla ProfilDoors. Obecnie kolekcja obejmuje 8 modeli w 3 kolorach.

## NK SERIES

This is a collection of panel doors which are coated with polypropylene film having unique texture that imitates oak timber cut. This coating was developed by Renolit (Munich). The collection includes 8 models in 3 colors.

3  
kolory8  
modeli

**DĄB BLEACHED SKY**  
BLEACHED SKY OAK

## CECHY KONSTRUKCYJNE

DESIGN FEATURES:



**DRZWI PRZESUWNE**  
Sliding door



**DRZWI PRZESUWNE IZYDA**  
Sliding door IZYDA



**DRZWI PRZESUWNE DIVA AIR**  
Sliding door Diva Air



**DRZWI PRZESUWNE MAGIC**  
Sliding door Magic



**SYSTEM OBROTOWY**  
Pivot system



**DRZWI SKŁADANE**  
Folding door



**DRZWI SKŁADANE COMPACT**  
Folding door Compact



**OŚCIEŻNICA UKRYTA**  
Invisible door frame



**SYSTEM BEZPRZYLGOWY**  
Frame for rabbit-free doors



**NAŚWIETLA / DOŚWIETLA**  
Transom / sidelight



**DRZWI DWUSKRZYDŁOWE**  
Double wing door



**AUTOMATYCZNY PRÓG**  
Automatic threshold



**OSZKLENIE NIEPRZE- PUSZCZAJĄCE ŚWIATŁA**  
Opaque glass glazing

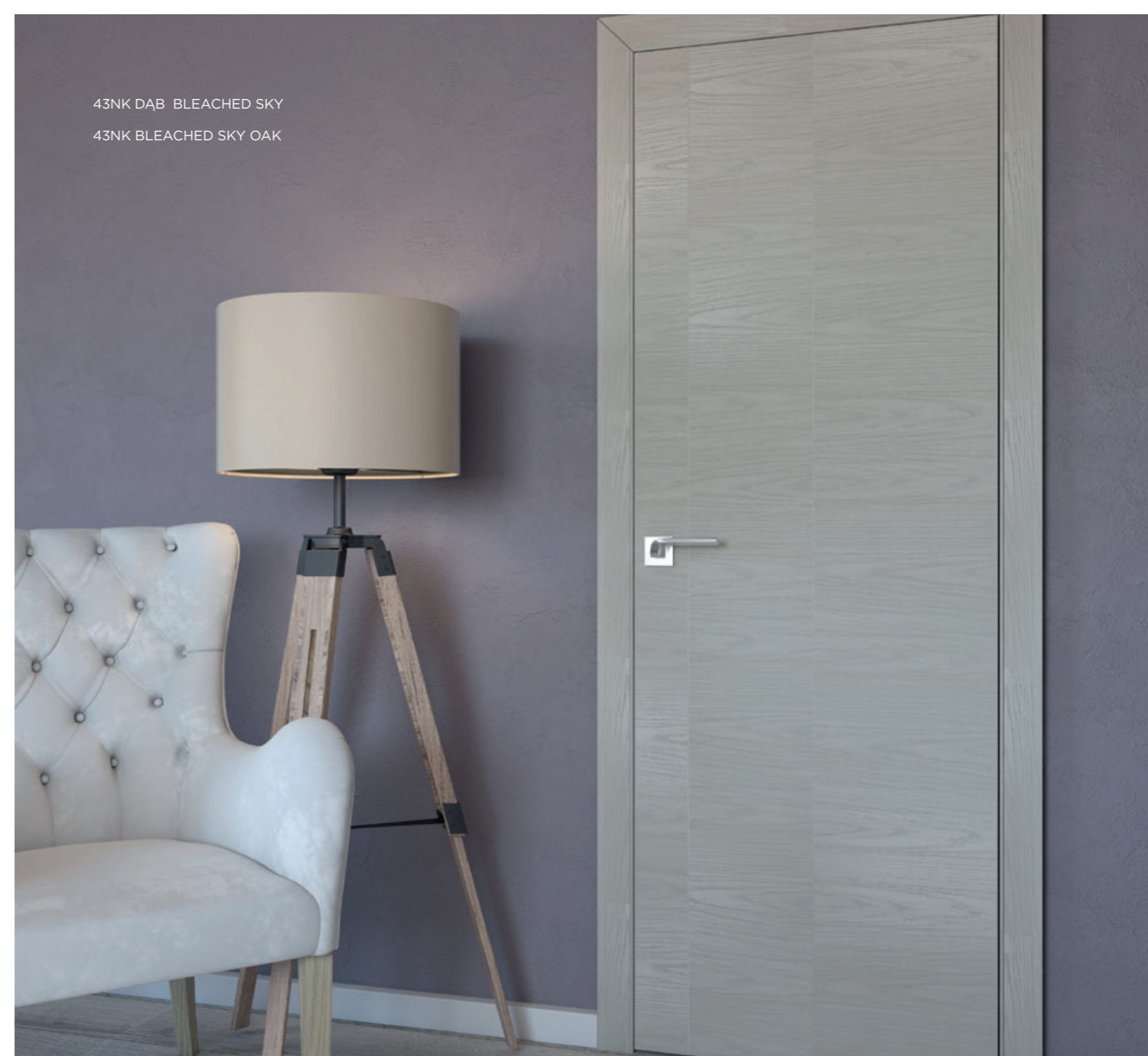

43NK DĄB BLEACHED SKY

43NK BLEACHED SKY OAK



## KOLORY TEKSTUR

COLOR  
TEXTURE

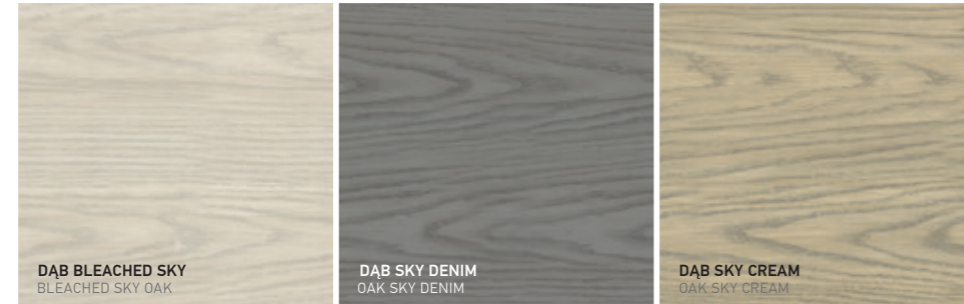

## OŚCIEŻNICA BEZPRZYLGOWA REGULOWANA

ADJUSTABLE FRAME  
FOR RABBET-FREE  
DOORS

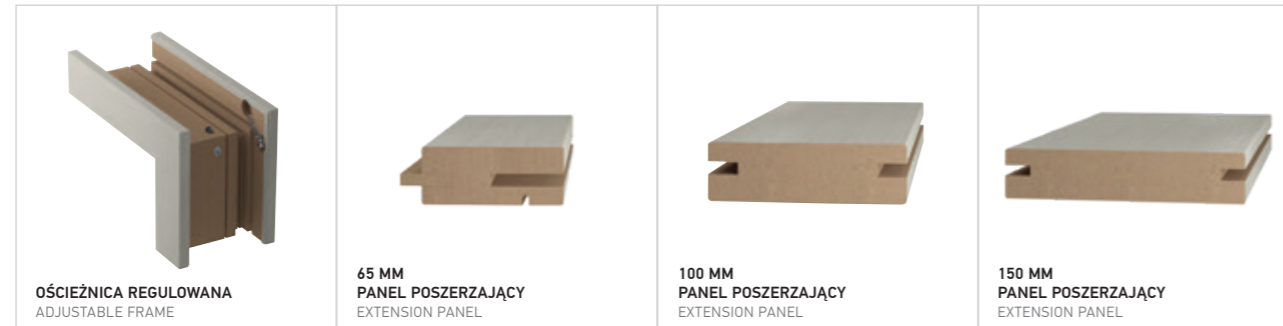

## NAKŁADKI DEKORACYJNE

DECORATIVE EDGE

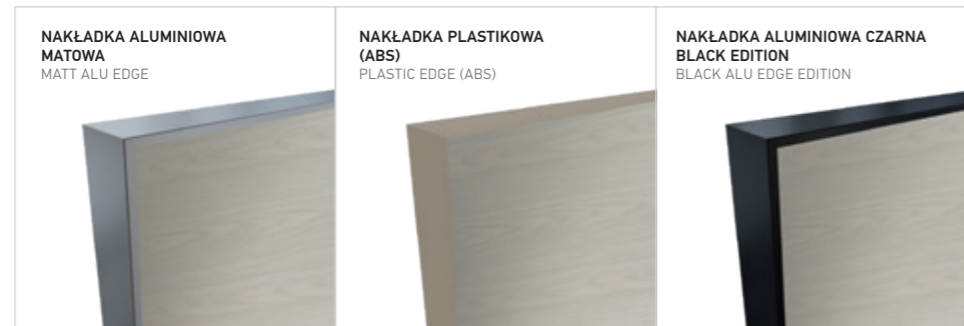

## OSZKLENIE GLASS PATTERNS

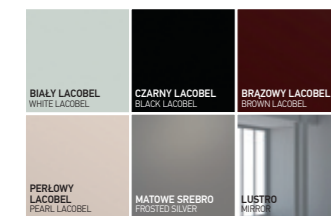

## MODELE MODELS



## WYKOŃCZENIE DECORATION





STK

SERIA STK

Kolekcja drzwi płytowych z najnowszym ekskluzywnym wykończeniem w postaci powłoki, imitującej teksturę naturalnego drewna, która została opracowana przez firmę Renolit (Monachium) na zamówienie ProfilDoors. Cechą szczególną tego wykończenia jest wyraźna i głęboka struktura „szcotkowana” pokryta jednobarwnym lakierem błyszczącym lub matowym. Seria zawiera szeroki asortyment drzwi we współczesnym minimalistycznym stylu. Obecnie kolekcja obejmuje 15 modeli w 3 kolorach.

## STK SERIES

This is a collection of panel doors which are finished with the newest unique film coating imitating natural veneer sheet texture. This coating was developed by Renolit (Munich) at the request of ProfilDoors. Clear and deep groovy surface covered with matt or glossy single-color lacquer is the most distinctive feature of this coating. This collection is represented by a wide choice of doors in modern minimalist style. The collection includes 15 models in 3 colors.

## CECHY KONSTRUKCYJNE

DESIGN FEATURES:



DRZWI PRZESUWNE  
Sliding door



DRZWI PRZESUWNE IZYDA  
Sliding door IZYDA



DRZWI PRZESUWNE DIVA AIR  
Sliding door Diva Air



DRZWI PRZESUWNE MAGIC  
Sliding door Magic



SYSTEM OBROTOWY  
Pivot system



DRZWI SKŁADANE  
Folding door



DRZWI SKŁADANE COMPACK  
Folding door Compack



OŚCIEŻNICA UKRYTA  
Invisible door frame



SYSTEM BEZPRZYLGOWY  
Frame for rabbit-free doors



NAŚWIETLA / DOŚWIETLA  
Transom / sidelight



DRZWI DWUSKRZYDŁOWE  
Double wing door



AUTOMATYCZNY PRÓG  
Automatic threshold



OSZKLENIE NIEPRZE-  
PUSZCZAJĄCE ŚWIATŁA  
Opaque glass glazing

3  
kolory

15  
modeli



SOSNA BIAŁA BŁYSZCZĄCA  
PINE WHITE

12STK SOSNA BIAŁA BŁYSZCZĄCA

12STK PINE WHITE WITH FOLDING SYSTEM COMPACK



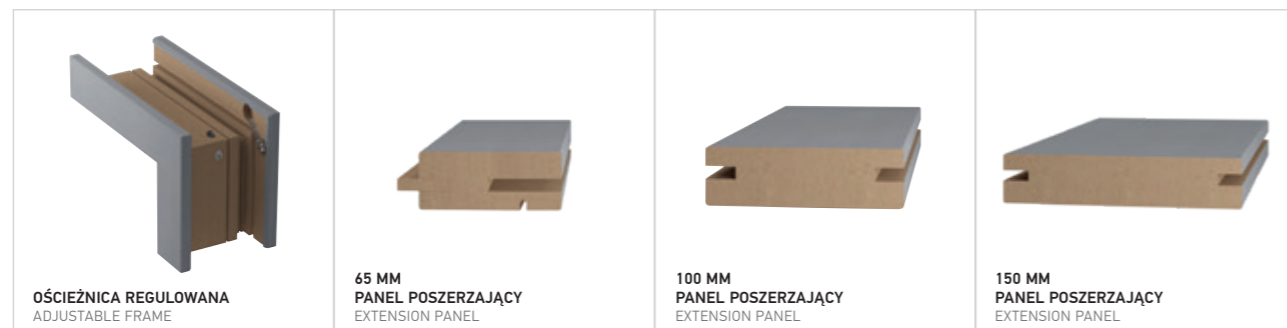

KOLORY  
TEKSTURTEXTURE  
COLORSOŚCIEŻNICA  
BEZPRZYLGOWA  
REGULOWANAADJUSTABLE FRAME  
FOR RABBET-FREE  
DOORSNAKLADKI  
ALUMINIOWE

DECORATIVE EDGE

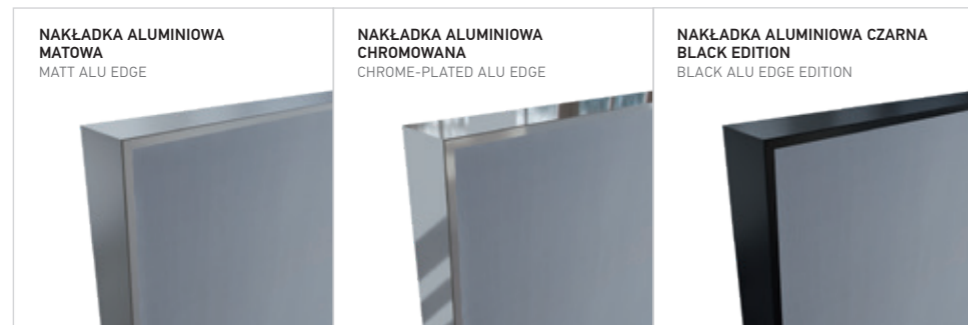

## OSZKLENIE GLASS PATTERNS

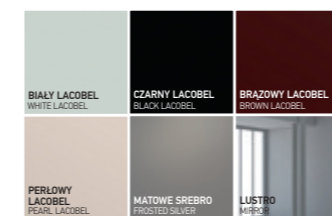

## MODELE MODELS



## WYKOŃCZENIE DECORATION

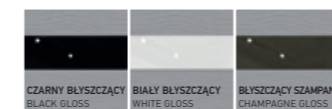

## MODELE MODELS



## WYKOŃCZENIE DECORATION



## MODELE MODELS





# LK

## SERIA LK

Kolekcja drzwi płytowych z błyszczącą powłoką, opracowaną w Niemczech. Powłoka ta wyróżnia się wysoką jakością powierzchni oraz połysku. Seria zawiera szeroki asortyment drzwi zarówno w klasycznej, jak i w nowoczesnej stylistyce. Obecnie kolekcja obejmuje 17 modeli w 4 kolorach.

4  
kolory

17  
modeli



MAGNOLIA LUX  
MAGNOLIA LUX

### LK SERIES

This is a collection of panel doors with glossy coating which was developed in Germany. This coating is notable for the superior quality of its surface and outstanding glittering effect. This collection is represented by a wide choice of doors both in classical and in modern styles. The collection includes 17 models in 4 colors

### CECHY KONSTRUKCYJNE

DESIGN FEATURES:



DRZWI PRZESUWNE  
Sliding door



DRZWI PRZESUWNE IZYDA  
Sliding door IZYDA



DRZWI PRZESUWNE DIVA AIR  
Sliding door Diva Air



DRZWI PRZESUWNE MAGIC  
Sliding door Magic



SYSTEM OBROTOWY  
Pivot system



DRZWI SKŁADANE  
Folding door



DRZWI SKŁADANE COMPACT  
Folding door Compact



OŚCIEŻNICA UKRYTA  
Invisible door frame



SYSTEM BEZPRZYLGOWY  
Frame for rabbit-free doors



NAŚWIETLA / DOŚWIETLA  
Transom / sidelight



DRZWI DWUSKRZYDŁOWE  
Double wing door



AUTOMATYCZNY PRÓG  
Automatic threshold



OSZKLENIE NIEPRZE-  
PUSZCZAJĄCE ŚWIATŁA  
Opaque glass glazing



1LK MAGNOLIA LUX

## KOLORY TEKSTUR

TEXTURE  
COLORS

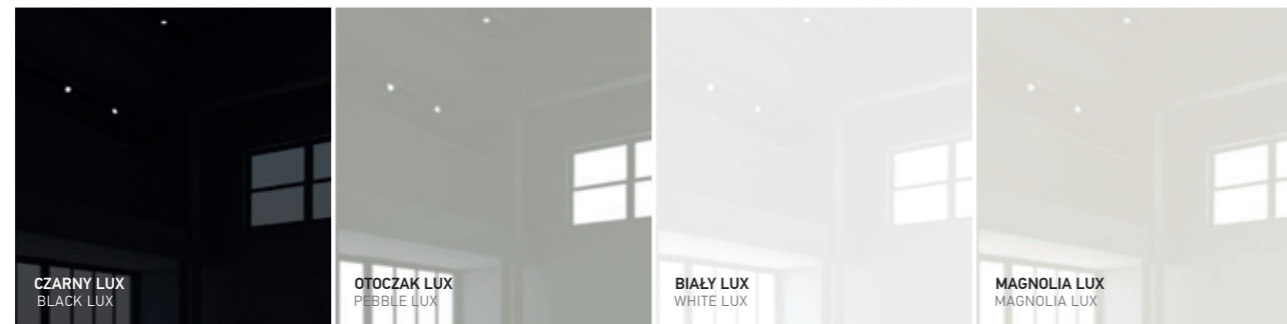

## OŚCIEŻNICA BEZPRZYLGOWA REGULOWANA

ADJUSTABLE FRAME  
FOR RABBET-FREE  
DOORS



## LISTWA DEKORACYJNA DLA MODELI OD 80LK DO 89LK

DECORATIVE  
MOLDINGS  
IN MODELS FROM 80LK TO 89LK



## NAKŁADKI DEKORACYJNE

DECORATIVE EDGE



## OSZKLENIE

GLASS PATTERNS

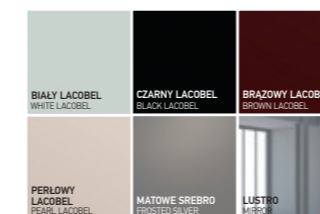

## MODELE

MODELS



## WYKOŃCZENIE

DECORATION

## MODELE

MODELS

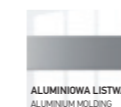

ALUMINIOWA LISTWA  
ALUMINIUM MOLDING





VG

SERIA VG

Kolekcja drzwi płytowych klasy premium z wykończeniem „wysoki połysk”, które nie ma sobie równych, jeśli chodzi o głębię i czystość połysku. Wykończenie posiada ochronną powłokę lakieru, która chroni przed przecieraniem, zarysowaniem i blaknięciem. Drzwi są wyposażone w zawiasy AGB Eclipse 2.0 oraz zamki 190 włoskiej produkcji. Istnieje możliwość zamówienia niemieckich zawiasów „Simonswerk” oraz zamków „KFV”. Obecnie kolekcja obejmuje 12 modeli w 3 kolorach.

## VG SERIES

This is a collection of premium panel doors with 'High Shine' coating, which is unique for its deep mirror-like effect. This coating is covered with lacquer which protects from scratches and fading of the colors. These doors are equipped with Italian AGB Eclipse 2.0 hinges and Italian AGB 190 locks. German 'Simonswerk' hinges and 'KFV' locks are also available on demand. The collection includes 12 models in 3 colors.

## CECHY KONSTRUKCYJNE

DESIGN FEATURES:



DRZWI PRZESUWNE  
Sliding door



DRZWI PRZESUWNE IZYDA  
Sliding door IZYDA



DRZWI PRZESUWNE DIVA AIR  
Sliding door Diva Air



DRZWI PRZESUWNE MAGIC  
Sliding door Magic



SYSTEM OBROTOWY  
Pivot system



DRZWI SKŁADANE  
Folding door



DRZWI SKŁADANE COMPACT  
Folding door Compact



OŚCIEŻNICA UKRYTA  
Invisible door frame



SYSTEM BEZPRZYLGOWY  
Frame for rabbit-free doors



NAŚWIETLA / DOŚWIETLA  
Transom / sidelight



DRZWI DWUSKRZYDŁOWE  
Double wing door



AUTOMATYCZNY PRÓG  
Automatic threshold



OSZKLENIE NIEPRZE-  
PUSZCZAJĄCE ŚWIATEŁA  
Opaque glass glazing

3  
kolory

12  
modeli



BIAŁY BŁYSZCZĄCY  
WHITE GLOSS



CZARNY BŁYSZCZĄCY  
BLACK GLOSS

1VG BIAŁY BŁYSZCZĄCY  
1VG CZARNY BŁYSZCZĄCY

1VG WHITE GLOSS INVISIBLE REVERS  
1VG BLACK GLOSS INVISIBLE





**KOLORY  
TEKSTUR**

TEXTURE  
COLORS

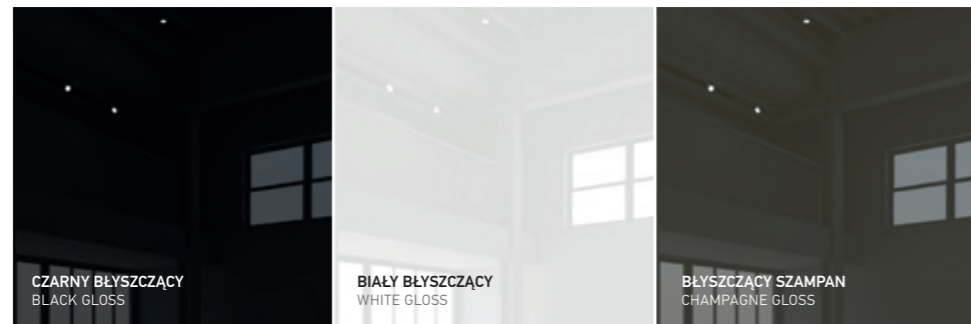

**CZARNY BŁYSZCZĄCY**  
BLACK GLOSS

**BIAŁY BŁYSZCZĄCY**  
WHITE GLOSS

**BŁYSZCZĄCY SZAMPAN**  
CHAMPAGNE GLOSS

**NAKŁADKI DEKORACYJNE** DECORATIVE EDGE

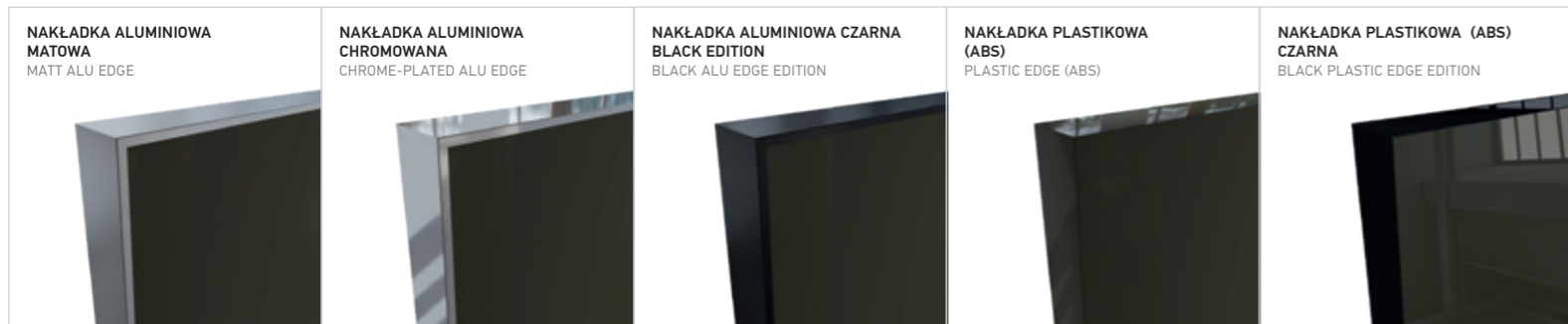

**NAKŁADKA ALUMINIOWA  
MATOWA**  
MATT ALU EDGE

**NAKŁADKA ALUMINIOWA  
CHROMOWANA**  
CHROME-PLATED ALU EDGE

**NAKŁADKA ALUMINIOWA CZARNA  
BLACK EDITION**  
BLACK ALU EDGE EDITION

**NAKŁADKA PLASTIKOWA  
(ABS)**  
PLASTIC EDGE (ABS)

**NAKŁADKA PLASTIKOWA (ABS)  
CZARNA**  
BLACK PLASTIC EDGE EDITION

**MODELE**  
MODELS



**1VG**

**FORNIR** VENEER

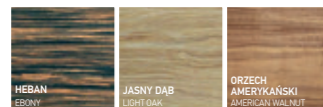

**HEBAN**  
EBONY

**JASNY DAB**  
LIGHT OAK

**ORZECH**  
AMERYKAŃSKI  
AMERICAN WALNUT

**MODELE** MODELS



**4VG**

**45VG**

**46VG**

**47VG**

**OSZKLENIE** GLASS PATTERNS

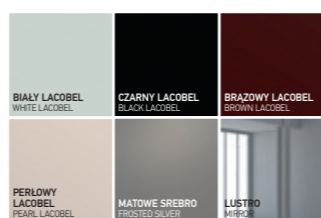

**BIAŁY LACOBEL**  
WHITE LACOBEL

**CZARNY LACOBEL**  
BLACK LACOBEL

**BRAZOWY LACOBEL**  
BROWN LACOBEL

**PERŁOWY LACOBEL**  
PEARL LACOBEL

**MATOWE SREBRO**  
FROSTED SILVER

**LUSTRO**  
MIRROR

**MODELE** MODELS



**10VG**

**WYKOŃCZENIE** DECORATION

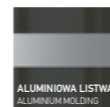

**ALUMINIOWA LISTWA**  
ALUMINIUM MOLDING

**MODELE** MODELS



**11VG**

**12VG**



**41VG**

**42VG**



**43VG**

**44VG**





SMK

SERIA SMK

Kolekcja drzwi płytowych klasy premium z ekskluzywnym wykończeniem „Soft Touch”, które nie ma sobie równych, jeśli chodzi o głębię matu i „miętkość” powierzchni.

W wykończeniu stosowane są elementy dekoracyjne z naturalnej skóry oraz kamienia. Drzwi są wyposażone w zawiasy AGB Eclipse 2.0 oraz zamki 190 włoskiej produkcji. Istnieje możliwość zamówienia niemieckich zawiasów „Simonswerk” oraz zamków „KFV”. Obecnie kolekcja obejmuje 5 modeli w 6 kolorach.

### SMK SERIES

This is a collection of premium panel doors with 'Seidematt' coating having unique matt texture depth and softness. Natural stone and genuine leather decoration is available. These doors are equipped with Italian AGB Eclipse 2.0 hinges and Italian AGB 190 locks. German 'Simonswerk' hinges and 'KFV' locks are also available on demand. The collection includes 5 models in 6 colors.

### CECHY KONSTRUKCYJNE

DESIGN FEATURES:

- |  |   |  |   |   |
|--|---|--|---|---|
|  <b>DRZWI PRZESUWNE</b><br>Sliding door         |  <b>DRZWI PRZESUWNE IZYDA</b><br>Sliding door IZYDA    |  <b>DRZWI PRZESUWNE DIVA AIR</b><br>Sliding door Diva Air             |  <b>DRZWI PRZESUWNE MAGIC</b><br>Sliding door Magic        |  <b>SYSTEM OBROTOWY</b><br>Pivot system              |
|  <b>DRZWI SKŁADANE</b><br>Folding door          |  <b>DRZWI SKŁADANE COMPACT</b><br>Folding door Compact |  <b>OŚCIEŻNICA UKRYTA</b><br>Invisible door frame                     |  <b>SYSTEM BEZPRZYLGOWY</b><br>Frame for rabbit-free doors |  <b>NAŚWIETLA / DOŚWIETLA</b><br>Transom / sidelight |
|  <b>DRZWI DWUSKRZYDŁOWE</b><br>Double wing door |  <b>AUTOMATYCZNY PRÓG</b><br>Automatic threshold       |  <b>OSZKLENIE NIEPRZEPUuszczAJĄCE ŚWIATŁA</b><br>Opaque glass glazing |   |   |

**6**  
kolorów

**5**  
modeli

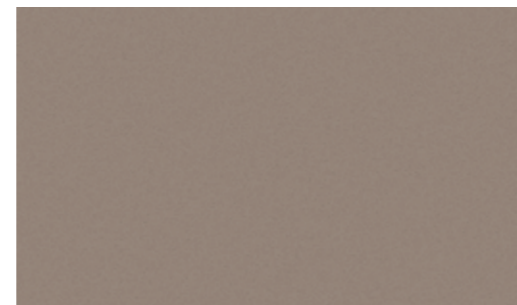

**KAKAO**  
COCOA



## KOLORY TEKSTUR

TEXTURE  
COLORS



## OŚCIEŻNICA BEZPRZYLGOWA REGULOWANA

ADJUSTABLE FRAME  
FOR RABBET-FREE  
DOORS

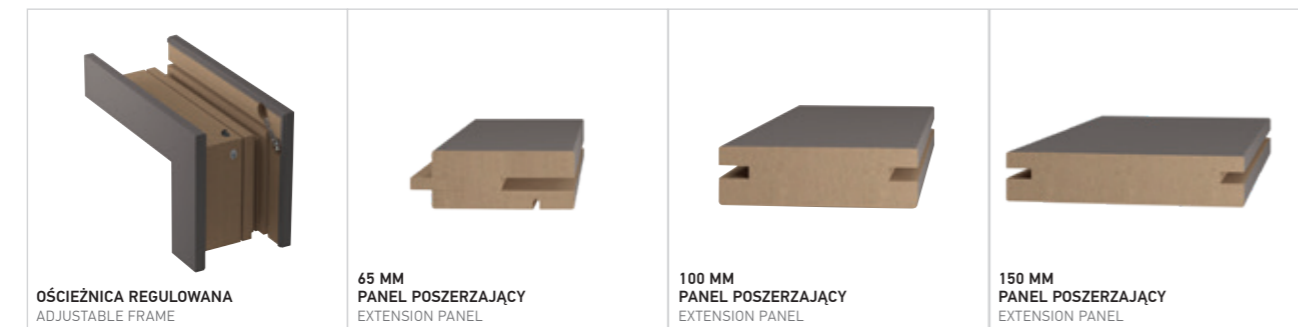

## NAKŁADKI DEKORACYJNE

DECORATIVE EDGE



## WYKOŃCZENIE

DECORATION



## MODELE

MODELS



1SMK

41SMK



42SMK

43SMK

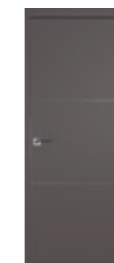

44SMK

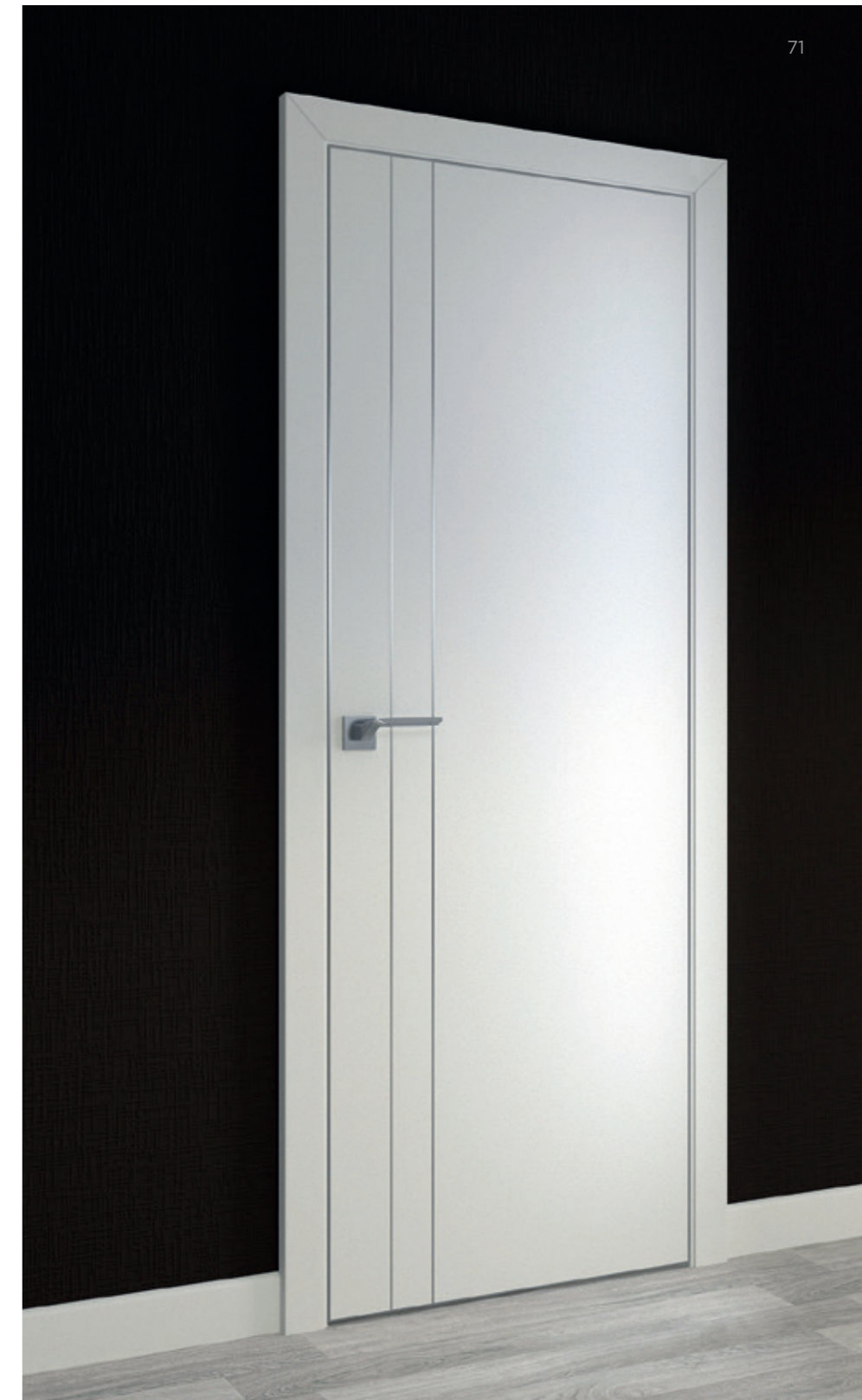



## AKCESORIA ACCESSORIES



**KLAMKA DND INTAKE MAT / CHROM / BIAŁA / CZARNA (WŁOCHY)**  
DOOR HANDLE DND INTAKE (MATT / CHROME-PLATED / WHITE / BLACK) (ITALY)

**ZAMEK AGB 190 Z MAGNESOWYM RYGLEM (WŁOCHY)**  
AGB 190 LOCK WITH MAGNETIC LATCH BOLT (ITALY)

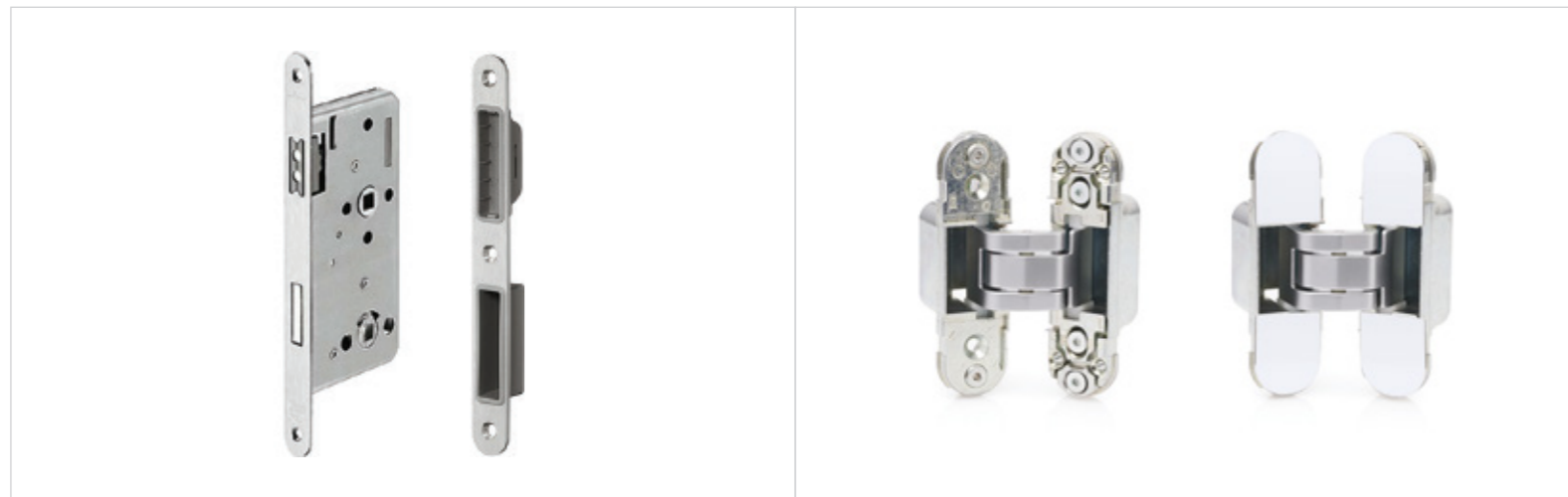

**ZAMEK POD BĘBENEK KFV Z MAGNESOWYM RYGLEM (NIEMCY)**  
KFV LOCK FOR CYLINDER WITH MAGNETIC LATCH BOLT (GERMANY)

**ZAWIAS AGB ECLIPSE 2.0 KRYTY WPUSZCZANY (WŁOCHY)**  
AGB ECLIPSE 2.0 CONCEALED HINGE (ITALY)

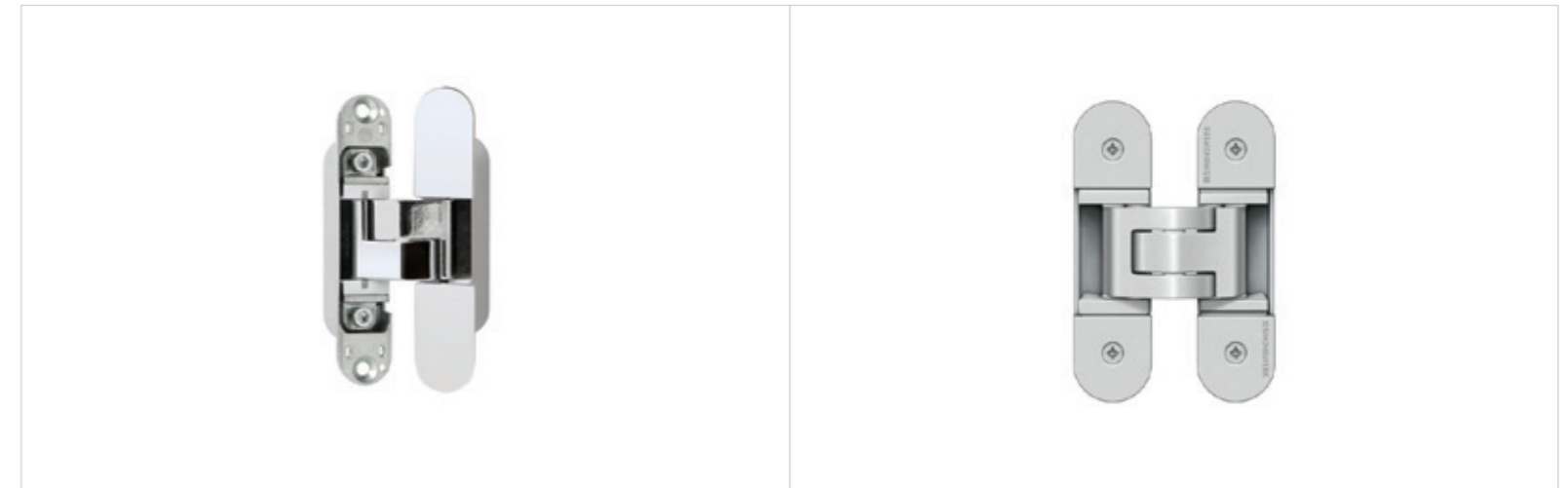

**ZAWIAS AGB ECLIPSE 3.0 KRYTY WPUSZCZANY (WŁOCHY)**  
AGB ECLIPSE 3.0 CONCEALED HINGE (ITALY)

**ZAWIAS SIMONSWERK TECTUS TE 303 KRYTY WPUSZCZANY (NIEMCY)**  
SIMONSWERK TECTUS TE 303 CONCEALED HINGE (GERMANY)

## SYSTEM OTWIERANIA INVISIBLE I INVISIBLE REVERS

Innowacyjne rozwiązanie pozwalające kreatywnie zaprojektować wnętrza. Po wykończeniu ściany, ościeżnica jest niewidoczna dla użytkownika. Rozwiązanie to powoduje uzyskanie jednolitej płaszczyzny skrzydła drzwiowego ze ścianą. Konstrukcja ościeżnicy pozwala na wykonanie drzwi ukrytych bardzo wysokich i połączenie ich bezpośrednio z sufitem. Drzwi występują w wersji bezprzylgowej – standardowo otwieranej na zewnątrz oraz w wersji z odwrotną przylgą – drzwi otwierane przez ościeżnicę. Drzwi ukryte to rozwiązanie dające nieograniczone możliwości. Można je pomalować farbą w kolorze ściany, nakleić tapetę lub położyć na nie tynk. Drzwi w systemie Invisible mogą mieć krawędź aluminiową: matową, chromowaną lub czarną. W systemie Invisible Revers krawędź może być aluminiowa matowa lub aluminiowa czarna.

System Invisible może być stosowany z modelami z serii: E, Z, ZN, STK, VG, SMK, LK. Albo z modelem OZ dostępnym w okleinie do wykończenia lub okleinie BETON PLATINUM.

SYSTEM OTWIERANIA INVISIBLE

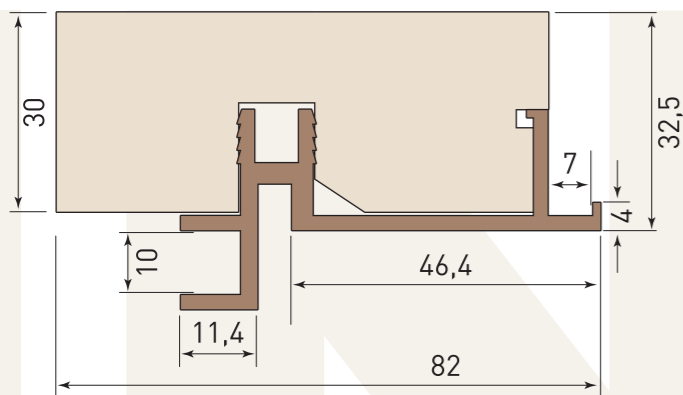

SYSTEM OTWIERANIA INVISIBLE REVERS

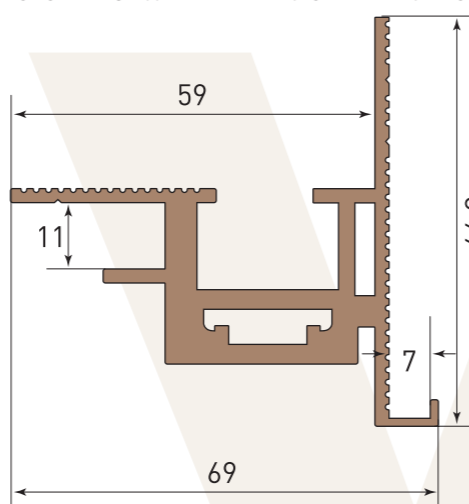

### CECHY KONSTRUKCYJNE

DESIGN FEATURES:



**OŚCIEŻNICA  
UKRYTA**  
Invisible door frame



**SYSTEM  
BEZPRZYLGOWY**  
Frame for rabbet-free doors



**SYSTEM  
Z ODWROTNĄ PRZYLGĄ**  
Frame



**AUTOMATYCZNY  
PRÓG**  
Automatic threshold



**OSZKLENIE NIEPRZE-  
PUSZCZAJĄCE ŚWIATŁA**  
Opaque glass glazing

### KOLORY TEKSTUR

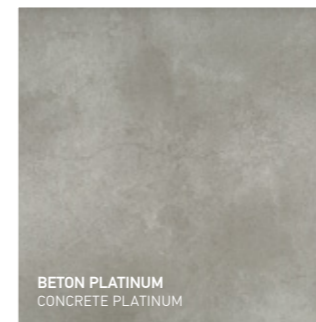
TEXTURE  
COLORSBETON PLATINUM  
CONCRETE PLATINUM

### NAKŁADKI DEKORACYJNE SYSTEM INVISIBLE I INVISIBLE REVERS

**NAKŁADKA ALUMINIOWA  
MATOWA**  
MATT ALU EDGE

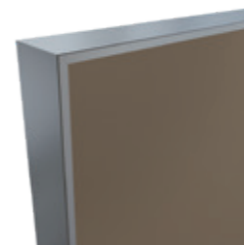

**NAKŁADKA ALUMINIOWA  
CHROMOWANA**  
CHROME-PLATED ALU EDGE

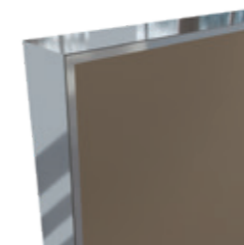

**NAKŁADKA ALUMINIOWA CZARNA  
BLACK EDITION**  
BLACK ALU EDGE EDITION



### NAKŁADKI DEKORACYJNE SYSTEM INVISIBLE

**NAKŁADKA PLASTIKOWA  
(ABS)**  
PLASTIC EDGE (ABS)



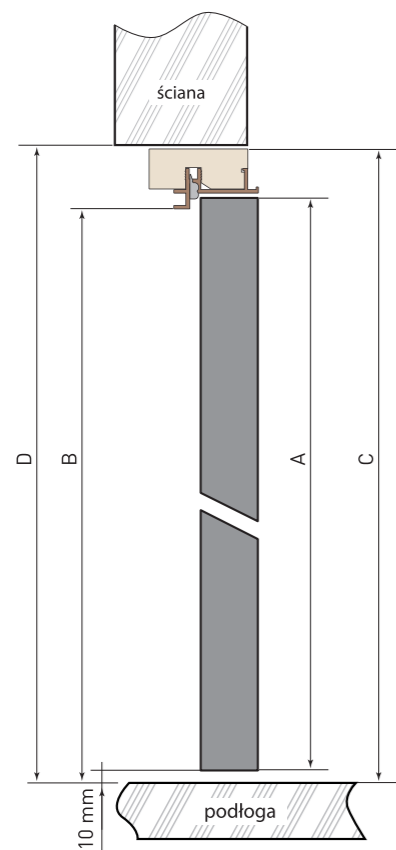
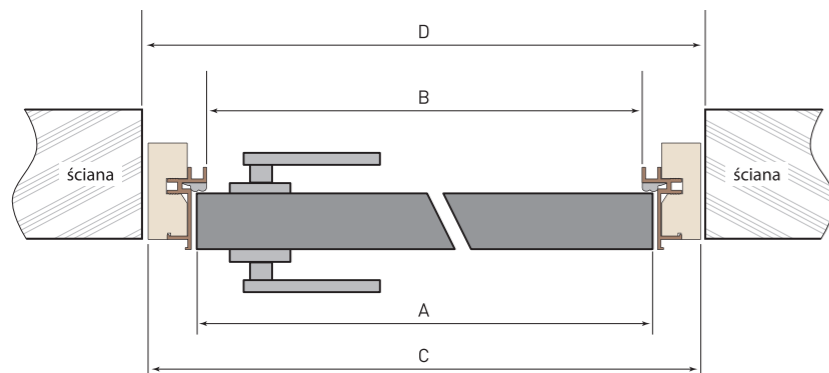

## PROFILDOORS

SYSTEM OTWIERANIA  
INVISIBLE

PRZEKRÓJ POZIOMY

A	B	C	D
400	388	473	513
450	438	523	563
500	488	573	613
550	538	623	663
600	588	673	713
650	638	723	763
700	688	773	813
750	738	823	863
800	788	873	913
850	838	923	963
900	888	973	1013
950	938	1023	1063
1000	988	1073	1113

PRZEKRÓJ PIONOWY

A	B	C	D
1800	1802	1864	1870
1850	1852	1914	1920
1900	1902	1964	1970
1950	1952	2014	2020
2000	2002	2064	2070
2050	2052	2114	2120
2100	2102	2164	2170
2150	2152	2214	2220
2200	2202	2264	2270
2250	2252	2314	2320
2300	2302	2364	2370
2350	2352	2414	2420
2400	2402	2464	2470
2450	2452	2514	2520
2500	2502	2564	2570
2550	2552	2614	2620
2600	2602	2664	2670
2650	2652	2714	2720
2700	2702	2764	2770
2750	2752	2814	2820
2800	2802	2864	2870
2850	2852	2914	2920
2900	2902	2964	2970
2950	2952	3014	3020
3000	3002	3064	3070

## PROFILDOORS

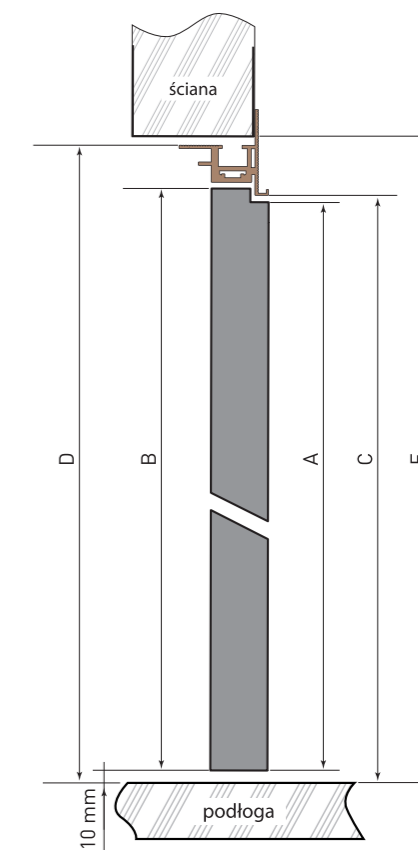
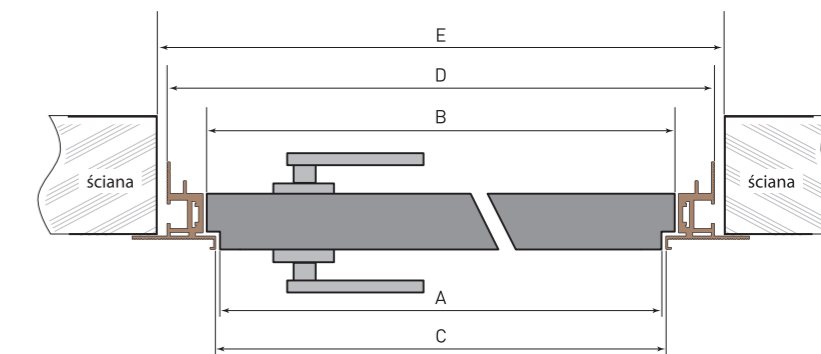
SYSTEM OTWIERANIA  
INVISIBLE REVERS

PRZEKRÓJ POZIOMY

A	B	C	D	E
400	420	374	488	500
450	470	424	538	550
500	520	474	588	600
550	570	524	638	650
600	620	574	688	700
650	670	624	738	750
700	720	674	788	800
750	770	724	838	850
800	820	774	888	900
850	870	824	938	950
900	920	874	988	1000
950	970	924	1038	1050
1000	1020	974	1088	1100

PRZEKRÓJ PIONOWY

A	B	C	D	E
1800	1810	1812	1852	1870
1850	1860	1862	1902	1920
1900	1910	1912	1952	1970
1950	1960	1962	2002	2020
2000	2010	2012	2052	2070
2050	2060	2062	2102	2120
2100	2110	2112	2152	2170
2150	2160	2162	2202	2220
2200	2210	2212	2252	2270
2250	2260	2262	2302	2320
2300	2310	2312	2352	2370
2350	2360	2362	2402	2420
2400	2410	2412	2452	2470
2450	2460	2462	2502	2520
2500	2510	2512	2552	2570
2550	2560	2562	2602	2620
2600	2610	2612	2652	2670
2650	2660	2662	2702	2720
2700	2710	2712	2752	2770
2750	2760	2762	2802	2820
2800	2810	2812	2852	2870
2850	2860	2862	2902	2920
2900	2910	2912	2952	2970
2950	2960	2962	3002	3020
3000	3010	3012	3052	3070

## ŚCIANKI DZIAŁOWE Z ALUMINIOWYCH PROFILI

Systemy przesuwnych ścianek działowych z aluminiowych profili to doskonałe rozwiązanie, które jest nie tylko sposobem na podzielenie przestrzeni pomieszczenia, ale jest też nowoczesnym i stylowym dodatkiem, który udoskonali wnętrze. Firma ProfilDoors oferuje przesuwne ścianki działowe, montowane z aluminiowych anodowanych profili, produkowanych z wykorzystaniem najnowszych technologii. Obecnie dostępne są trzy kolory profili. Jako wypełnienie ścianek działowych do wyboru jest szkło hartowane lub wielowarstwowe różnych modeli. Systemy przesuwnych ścianek działowych są wyposażone w akcesoria włoskich producentów.

### ALUMINIUM FRAMED DIVIDERS

System of sliding dividers made of aluminium profiles is the perfect solution for room space separating, as well as modern and stylish contribution to your interior. PofilDoors offers sliding dividers assembled out of special anodized aluminium profiles which are manufactured using the newest technology. Three colors are currently available. Tempered glass and various types of laminated glass are available for glazing. Dividers are equipped with Italian accessories.

**3**  
kolory

**5**  
modeli



**KONIAKOWY**  
COGNAC





## INFORMACJE TECHNICZNE

Ościeżnica wykonana jest z płyty MDF. Okleina dopasowana do okleiny drzwi. Konstrukcja przystosowana jest do skrzydła o grubości 36 mm dla serii X, U, XN, N, L, STP oraz 44 mm dla serii Z, E, ZN, NK, STK, LK. Konstrukcja pozwala stosować ościeżnicę do ścian o grubości od 79 do 288 mm oraz na regulację 60 mm. Dla szerokości 79 mm konieczne jest skrócenie pióra opaski i ościeżnicy.

W skład kompletu wchodzi: ościeżnica regulowana składająca się z elementu poziomego i dwóch elementów pionowych wraz z opaską 60 lub 80 mm, uszczelka drzwiowa, zestaw zawiasów oraz komplet elementów przeznaczonych do zamontowania ościeżnicy.

Ościeżnice pakowane są w opakowania kartonowe.

OŚCIEŻNICA REGULOWANA	A	B	C	D	E
<b>95</b>	133	112	100	95	79
<b>135</b>	173	152	140	135	119
<b>185</b>	223	197	190	185	169
<b>250</b>	288	262	255	250	234

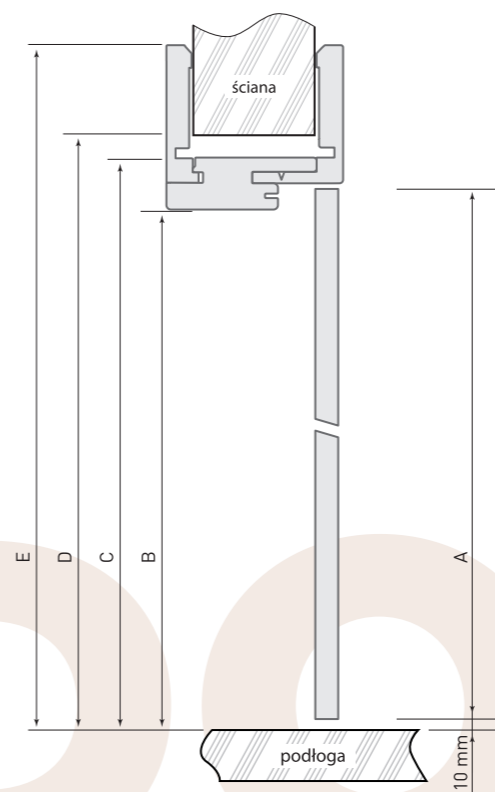
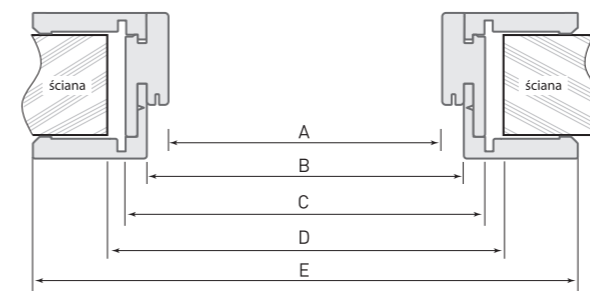
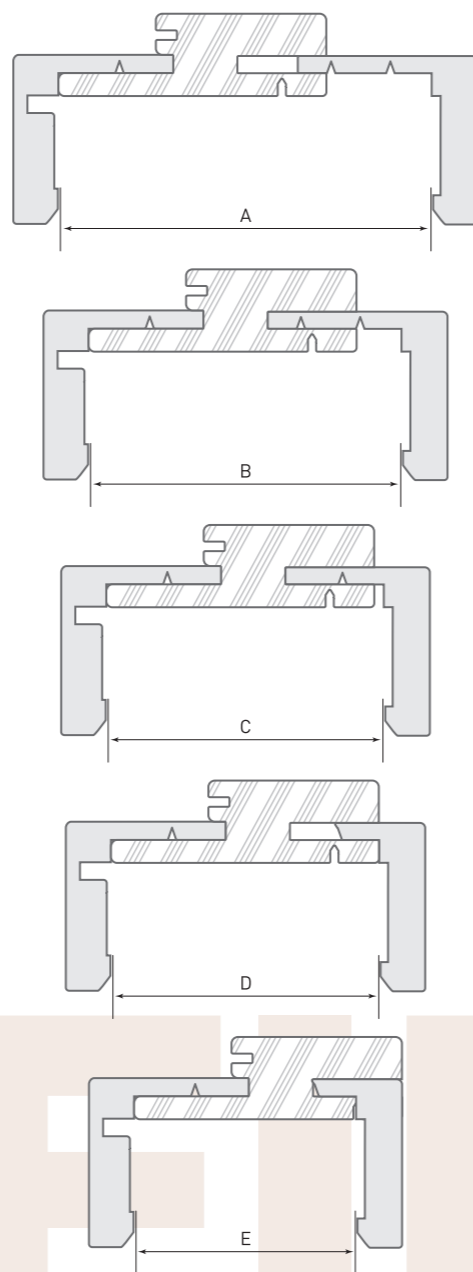

## INFORMACJE TECHNICZNE

### PRZEKRÓJ POZIOMY

A	B	C	D	E
578	600	638	678	768
628	650	688	728	818
678	700	738	778	868
728	750	788	828	918
<b>778</b>	<b>800</b>	<b>838</b>	<b>878</b>	<b>968</b>
828	850	888	928	1018
878	900	938	978	1068
928	950	988	1028	1118
978	1000	1038	1078	1168

### PRZEKRÓJ PIONOWY

A	B	C	D	E
1800	1799	1829	1849	1890
1850	1849	1879	1899	1940
1900	1899	1929	1949	1990
1950	1949	1979	1999	2040
<b>2000</b>	<b>1999</b>	<b>2029</b>	<b>2049</b>	<b>2090</b>
2020	2019	2049	2069	2110
2050	2049	2079	2099	2140
2100	2099	2129	2149	2190
2150	2149	2179	2199	2240
2200	2199	2229	2249	2290
2250	2249	2279	2299	2340
2300	2299	2329	2349	2390
2350	2349	2379	2399	2440
2400	2399	2429	2449	2490
2450	2449	2479	2499	2540
2500	2499	2529	2549	2590
2550	2549	2579	2599	2640
2600	2599	2629	2649	2690

## SIEĆ DYSTRYBUCJI

### DISTRIBUTION NETWORK



- |             |            |                |                 |            |
|-------------|------------|----------------|-----------------|------------|
| 1. ROSJA    | 5. ŁOTWA   | 9. RUMUNIA     | 13. TADŻYKISTAN | 17. KUWEJT |
| 2. POLSKA   | 6. ESTONIA | 10. MOŁDAWIA   | 14. KIRGISTAN   | 18. USA    |
| 3. BIAŁORUŚ | 7. NIEMCY  | 11. KAZACHSTAN | 15. MONGOLIA    |            |
| 4. LITWA    | 8. WŁOCHY  | 12. UZBEKISTAN | 16. GRUZJA      |            |

## NOTATKI

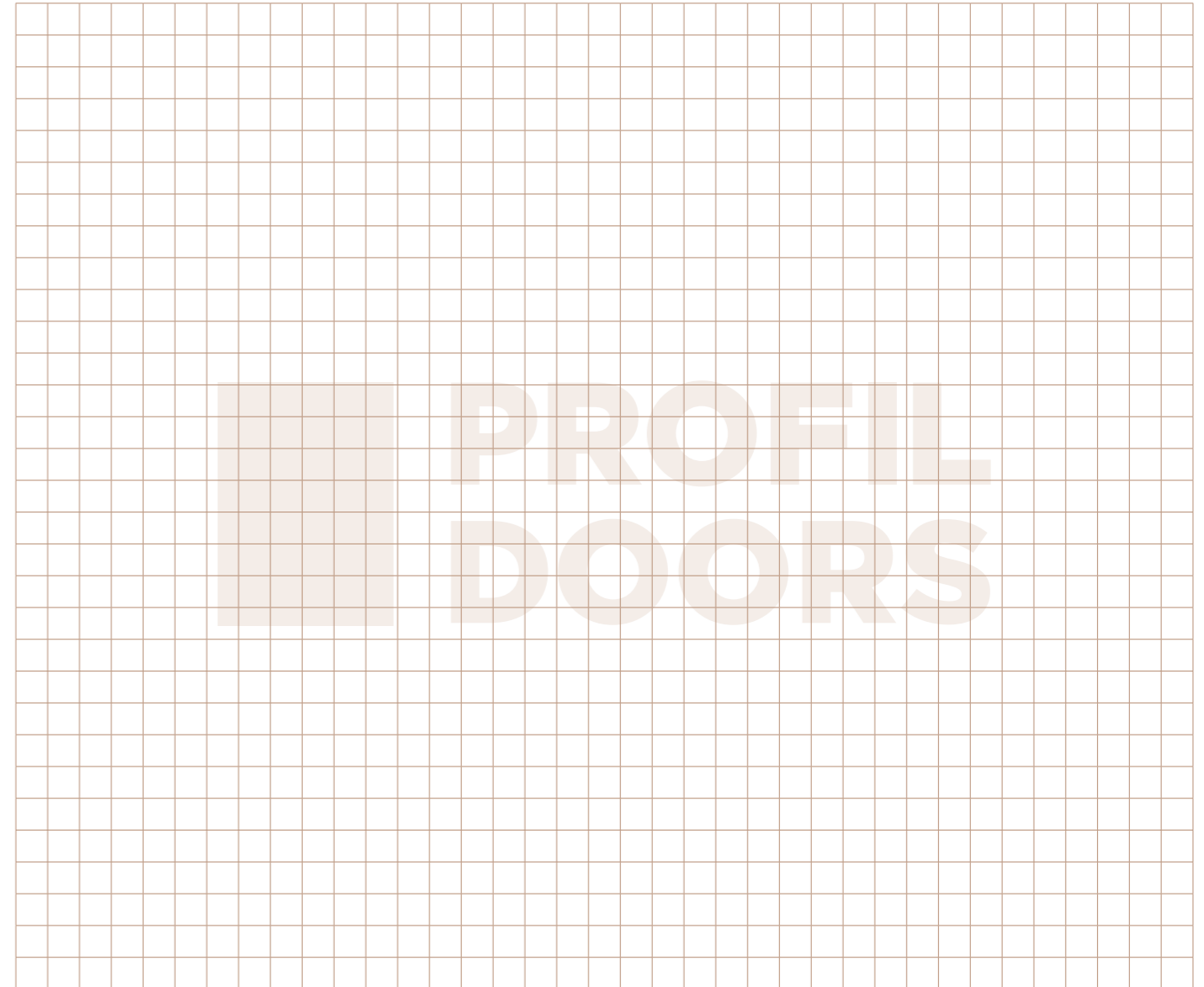



**NOTATKI**